

DOORS & WINDOWS

Redefining the Possibilities



About Us



As an industry leader for more than 20 years, Solar Innovations® has a long history that is rooted in the heart of manufacturing with a deep passion for the American dream. As a single source provider of custom glass structures, skylights, windows, doors, and more, Solar Innovations® strives to endlessly innovate and design custom products throughout the world. Our products continue to develop and grow as a direct result of our dedication to the industry and the creativity of our customers.

By investing in our team and customers, we are proud to turn dreams into reality. All of our American-made products are designed and manufactured at our campus in Pine Grove, PA, allowing for more flexibility to provide superior products and services. In addition, most of our engineering, product testing, and product designing take place within our facility. By producing as many components as possible in-house, we have greater control over quality, lead times, and cost, which ultimately achieves better results for our customers.

Although Solar Innovations® comes from small and humble beginnings, we now reside in a 400,000-square-foot office and manufacturing space. With a three-building campus located on over 36 acres of land, our company continues to develop and grow by creating innovative designs and engineering new product lines. The Solar Innovations® team strives to forge its path into the future by promoting a strong spirit of unity, with the desire to be better today than yesterday.

Contents

2	Design Considerations
4	For Your Home or Business
6	Complete Glazing Packages
7	Performance
8	Folding Glass Walls
12	Slide & Stack Glass Walls
16	Life Slide Doors
18	Sliding Glass Doors
20	Pivot Doors
22	Clear Glass Walls
24	Swing Doors
26	Window Systems
29	Wood Curtain Walls
30	Aluminum Curtain Walls
32	System Comparison
34	Finish Options
35	Choosing the Right Frame
36	Hardware Options
38	Sill Options
39	Glazing Options
40	Screen Options
41	Our Process

Why Solar Innovations®?

INNOVATIVE

Solar Innovations® – it's in the name. By constantly introducing new ideas with creative ways of thinking, our decisions take standard products to the next level. No project is too big or too small for us to handle.

DURABLE

With two in-house test labs, the quality of our products is second to none and includes some of the highest ratings in class. Solar Innovations® offers a vast line of certified products, including NFRC, AAMA, Florida Impact, Miami Dade, and TDI. Our products can be specifically designed and engineered to your project location.

HIGH-PERFORMING

At Solar Innovations®, we are about superior results. Our company currently offers the largest, impact-rated folding glass walls on the market and constantly strives to create the highest quality product possible.

SINGLE SOURCE PROVIDER

We are a single source supplier of aluminum and wood glazing systems, making your entire project cohesive. Solar Innovations® provides all fasteners, silicone, sill flashings, and project specific shop drawings.

ECO-FRIENDLY PRODUCTS

We are proud that our materials are sourced from local suppliers; not only does this help boost our local economy, but also reduces transportation times and fuel emissions. Our high thermal-performance products are energy-efficient for homes and commercial spaces. Even more, our systems include recycled content and are LEED friendly. LEED credits are available in the following categories: Materials & Resources (recycled content), Indoor Environmental Quality (daylight), Energy & Atmosphere (performance), and Regional Priority (within 500 miles of our facility). Depending on the application, other credits may also apply. Solar Innovations® was designed to be a LEED Gold certified manufacturing facility.

EASY TO OPERATE

All of our systems are user-friendly and straightforward. No matter the shape, size, or type of project you may have, our products remain practical and manageable for the ultimate customer experience.

COASTAL APPLICATIONS

Our systems can be designed to meet coastal requirements, limiting visible wear and tear. We have advanced aluminum finishes and stainless steel components, reducing the corrosive effects of the elements in coastal regions.

INSTALLATION

Whether a product is purchased directly from our manufacturing facility or through our dealer network, Solar Innovations® can provide installation and service for all of our products within a six-hour radius of Pine Grove, PA. Our expertly-trained team is registered to complete installation and service work in an ever-increasing number of states (contact our sales department for a current listing).

REPAIR & REPLACEMENT SERVICES

Our team has the technical skill and experience to evaluate your situation and determine the most effective options for repair, service, or replacement of your door or window. All drawings and information are saved for each project, so a site visit will not always be required.



RESIDENCE
SANDUSKY, OH
True Radius Segmented Dome Skylight

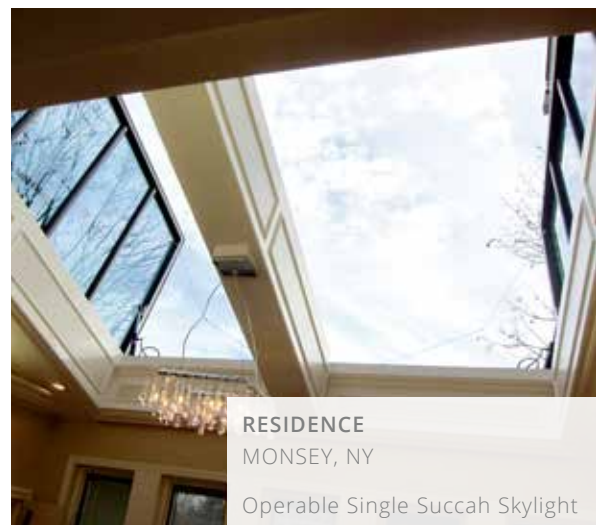

RESIDENCE
MONSEY, NY
Operable Single Succah Skylight

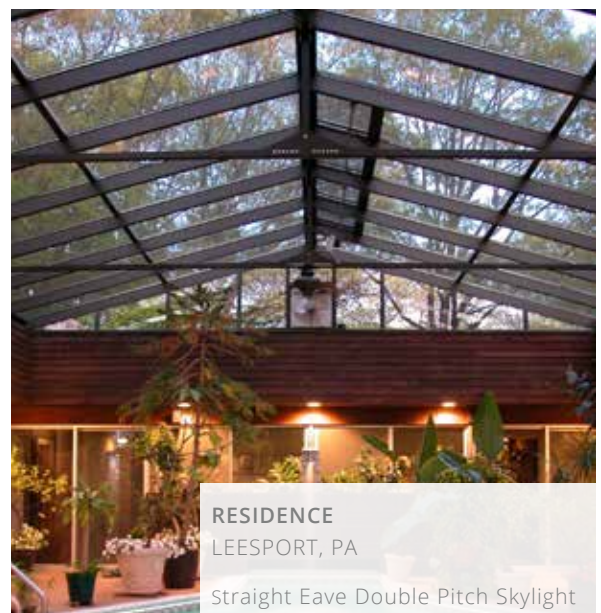

RESIDENCE
LEESPORT, PA
Straight Eave Double Pitch Skylight

Design Considerations



RESIDENCE
GROTON, MA

G2 Multi-Track Sliding Glass Doors

LOCATION

When choosing the location of a door or window, sun exposure should be taken into consideration.

- South-facing: Receives the most consistent amount of direct sunlight and passive heat gain.
- North-facing: Receives diffused light levels throughout the day.
- East-facing: Receives early morning light and warmth.
- West-facing: Receives the majority of their solar exposure during the afternoon and evening hours.

BUILDING REGULATIONS

Since it is important to adhere to municipal ordinances from the start of the project, we recommend submitting preliminary plans for approval to your local regulatory agency. Solar Innovations® can create renderings for this process.

CONFIGURATIONS/LAYOUT

The first thing to be considered is the size of the wall opening (rough frame size opening) for the doors and windows. The units need to be identified as either stationary or operable.

The next thing to consider is the layout of the doors and windows, once opened and how they will affect the space. This may determine if a door will be inswing or outswing, or if a window will be sliding or casement. Additionally, some systems can be concealed in a pocketed area to be hidden from view.

DOOR SIZE

There are two sizes that need to be considered when planning for a new door: the rough-frame size opening and the finished-frame size opening. The rough opening is the size of the opening in the wall and needs to accommodate the size of the door and its framework; the finished frame size is that of the actual door. For example, if your door is 80" high, the rough opening needs to be greater for the door and framework to fit. The additional space needed varies per system and our sales team can assist you in determining the right dimensions.

SILL TYPES

A sill is the threshold of a doorway that forms the bottom of a door frame. The configuration of the door and window system will determine the size, number, and position of tracks needed in the sill. Sills can be mounted two ways; a surface mounted sill is attached to the floor, while a recessed sill is embedded into the floor, making it less conspicuous. We also offer ADA-compliant sills. Depending on your location, local thermal and water performance code requirements may affect your sill choice.

ATTACHING MATERIAL/SUBSTRATES

It is important to identify the type of material that the system will be attached. The material may differ between the sill, jamb, and head. For example, a sill may be recessed in a concrete floor while the jamb is attached to wood and the head is attached to steel. Solar Innovations® can provide attachment details and load information for varying substrates.



RESIDENCE
BAINBRIDGE ISLAND, WA
G2 Outswing Offset Pivot Door
& G2 Outswing Terrace Door

INTERIOR OR EXTERIOR

Since interior and exterior doors have different requirements, the location of the opening should be one of the first factors considered. For example, an interior door may not require high-performance glazing or thermally-enhanced aluminum framing like an exterior door since it does not come into contact with the elements.

VENTILATION

Operable doors and windows can promote convection and cross ventilation in your space. A well-designed ventilation layout can provide fresh air and lower temperatures where an abundance of glass tends to yield solar heat gain. Low-positioned doors and windows act as fresh air intakes while ones positioned higher act as exhaust points. Ideally, they should be positioned without major obstructions within the ventilation pathway. A single story home can utilize operable door transoms to act as points of exhaust.



RESIDENCE
YORKVILLE, ONTARIO, CANADA
G2 Folding Glass Wall

TOP OR BOTTOM LOADING

Some products can be supported, or bear the load, by the head (top) or the sill (bottom) of the frame. Top supported folding doors are preferred, with the rollers placed in the head track. This prevents exposure to foot traffic experienced at the sill, where dirt and debris can affect the operation of the rollers. For top load systems, the header cannot deflect (sag) more than 1/4" along its span under the weight of the system. Our engineering department can provide load information for your project. Bottom load options are also available.

For Your Home or Business

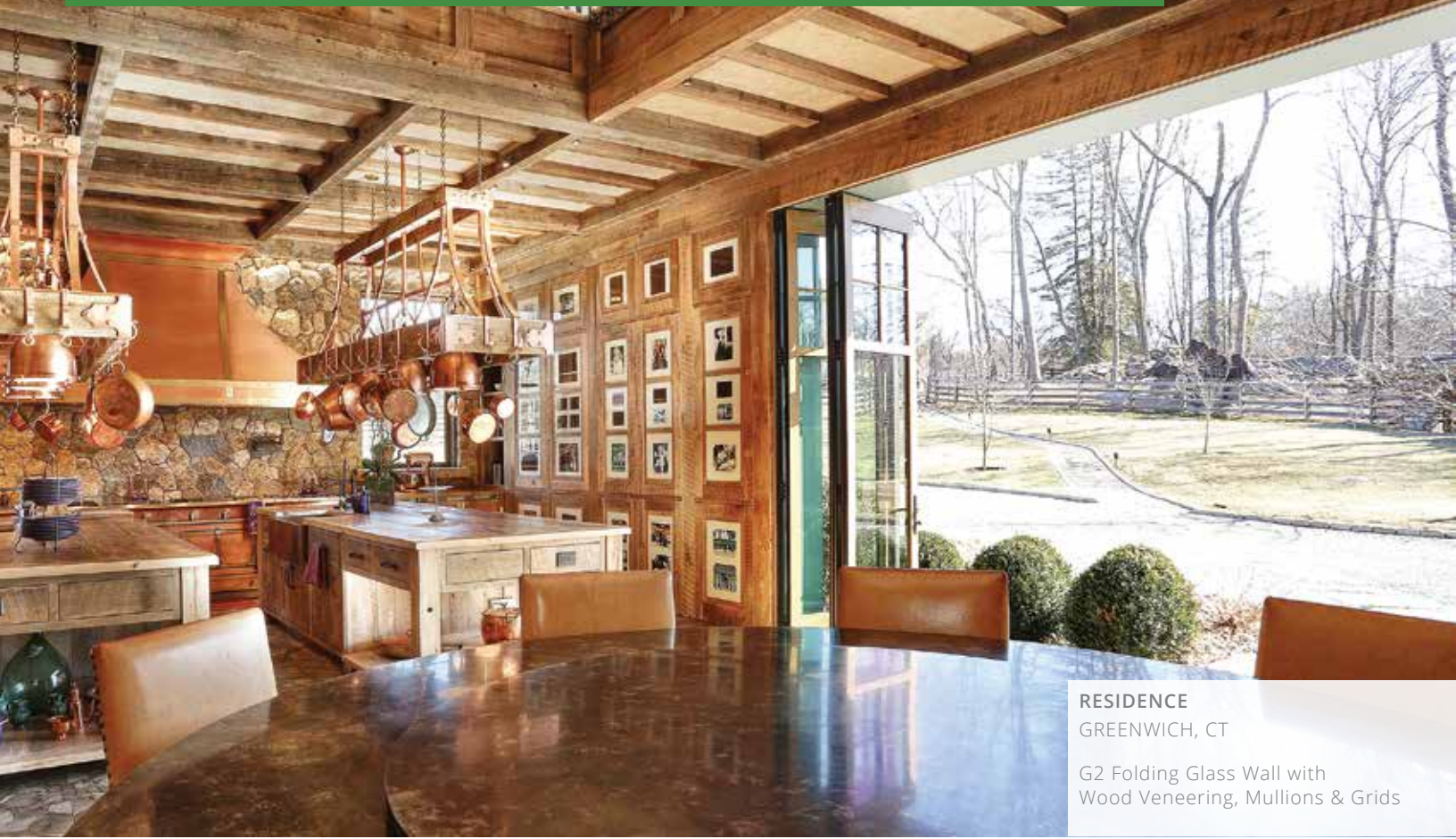

RESIDENCE
GREENWICH, CT
G2 Folding Glass Wall with Wood Veneering, Mullions & Grids

Bring Luxury Home

Solar Innovations® doors and windows add a unique feature to any home while expanding a room's natural view. Many of our signature products are designed with strength, durability, and ultimate performance in mind. Our manufacturing process ensures you're receiving the highest quality door or window system that will last for decades.

ENERGY EFFICIENT

Our operable walls can be designed with thermally-broken or nonthermal profiles.

LIMITLESS CONFIGURATIONS

Remote stacking, pocketing, no post 90° corners, segmented radiuses, and integrated swing doors are just some of the options offered. Customizations are available.

EASILY OPERABLE

Our systems offer single-handed operation, resulting in smooth movement with minimal effort.

MAXIMUM TRANSPARENCY

Sleek sightlines maximize views. Our units can accommodate any single, double, or triple glazed infill up to 1½" (thicker units may be possible upon request).

OVERSIZED PANEL OPENINGS

Capitalizing on our local engineering and manufacturing location, we take pride in working with designers to accommodate the largest panel sizes possible, while maintaining maximum performance.

MOTORIZED OPTIONS

Our sliding glass doors, swing doors, and awning, casement, and hopper windows can be motorized. Other options are available with engineering department approval.



RESIDENCE
SARASOTA, FL
G2 Folding Glass Wall Systems, French Door & G2 Inswing Pivot Door

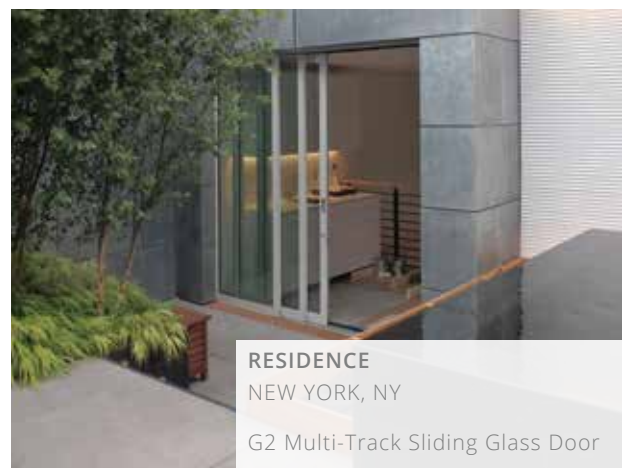

RESIDENCE
NEW YORK, NY
G2 Multi-Track Sliding Glass Door

Creating Unforgettable Experiences for Your Business

RESTAURANTS

Heighten a customer's experience by bringing the outdoors in. Folding glass walls or multi-track sliding glass doors, along with our window systems, provide minimal sightline obstruction. Enhanced glass options give your space the strength and durability it needs to withstand almost any weather.

EDUCATIONAL FACILITIES

Natural daylighting and larger, more flexible spaces are trending in educational facilities. Our operable door systems allow for multiple room configurations, open campus centers, and better learning environments.

OFFICES & INTERIORS

Operable walls are ideal for offices spaces, creating a flexible, multi-purpose environment. Rooms can be segmented for private meetings or opened up to accommodate larger gatherings. Many of our systems have superior acoustical performance.

HOTELS

Our commercial products for hotel guest rooms, lounges, and lobby areas allow for beautiful views, natural daylight, and fresh air. For guest convenience, our sliding glass doors can be motorized.

RETAIL

Retail spaces use sliding storefront systems to maximize sightlines and attract customers, showcasing their merchandise in a more open and inviting fashion. Our clear glass walls, or slide and stack walls, provide excellent solutions for any indoor/outdoor retail space. Our multi-point locking systems keep the property secure.

STADIUMS

Since 1998, we have been creating high-performance products for stadiums that enhance the fan experience. Our folding, stacking, and clear glass walls have been integrated into stadium press boxes, club seats, luxury suites, and stadium side bars and restaurants. With its ease of operation, these systems are an excellent choice for any sports arena.



**DARTMOUTH COLLEGE
HOUSE CENTER**
HANOVER, NH

G3 Dual Track Sliding Glass Doors

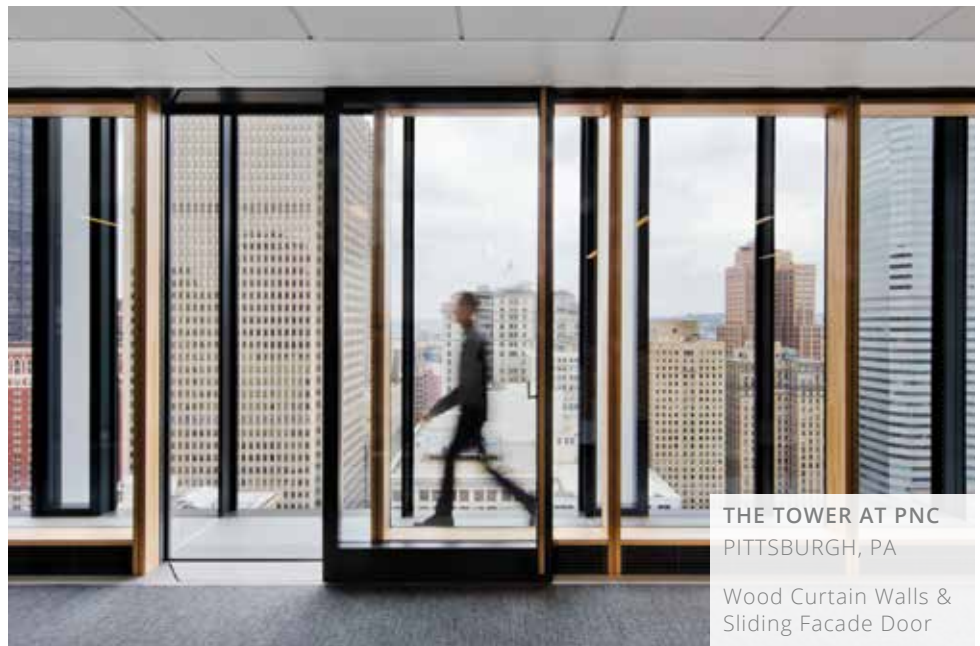

THE TOWER AT PNC
PITTSBURGH, PA

Wood Curtain Walls &
Sliding Facade Door

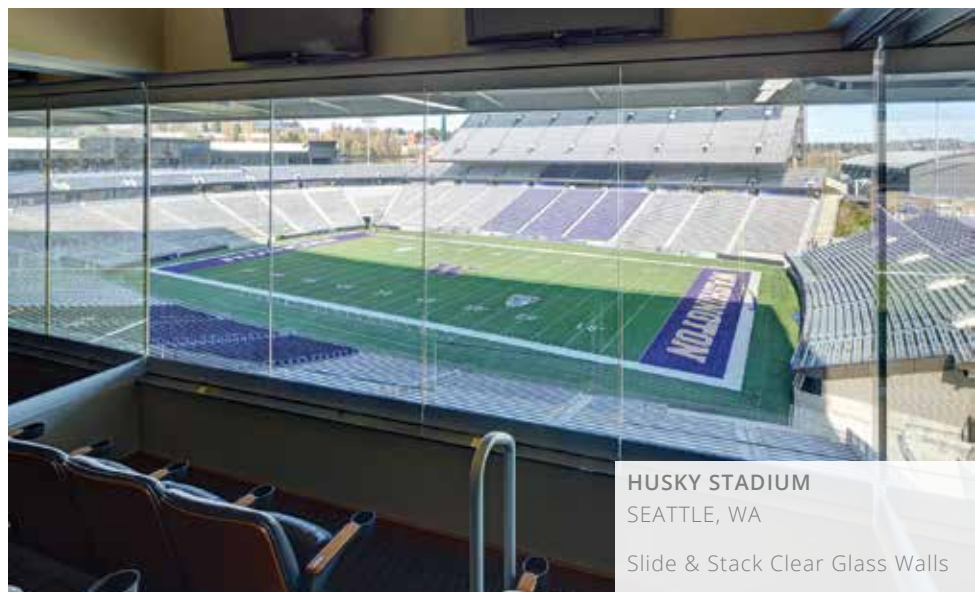

HUSKY STADIUM
SEATTLE, WA

Slide & Stack Clear Glass Walls

Complete Glazing Packages



RESIDENCE
EAST HAMPTON, NY

G2 Multi-Track Sliding Glass Doors & G2 Offset Pivot Door

Superior Solutions

Doors and windows are often purchased at the same time, but from different manufacturers. This can create a disparity in sightlines, finishes, and the overall aesthetics of the structure. Solar Innovations® can provide you with a door and window package that will ensure consistent sightlines, colors, and warranties.

Our aluminum framing will not rot, rust, warp, or require constant finish maintenance. Utilizing framing by the same manufacturer will ensure your doors and windows have a similar lifespan.

DOOR & WINDOW OPTIONS:

- Awning Windows
- Casement Windows (Inswing & Outswing)
- Hopper Windows
- Fixed Windows
- Tilt Turn Windows
- Terrace & French Doors
- Sliding Glass Doors & Windows
- Folding Glass Walls & Windows
- Stacking Glass Walls & Windows
- Pivot Doors & Windows
- Lift Slide Doors
- Curtain Walls (Aluminum & Wood)
- Window Walls
- Skylights
- Unique custom systems

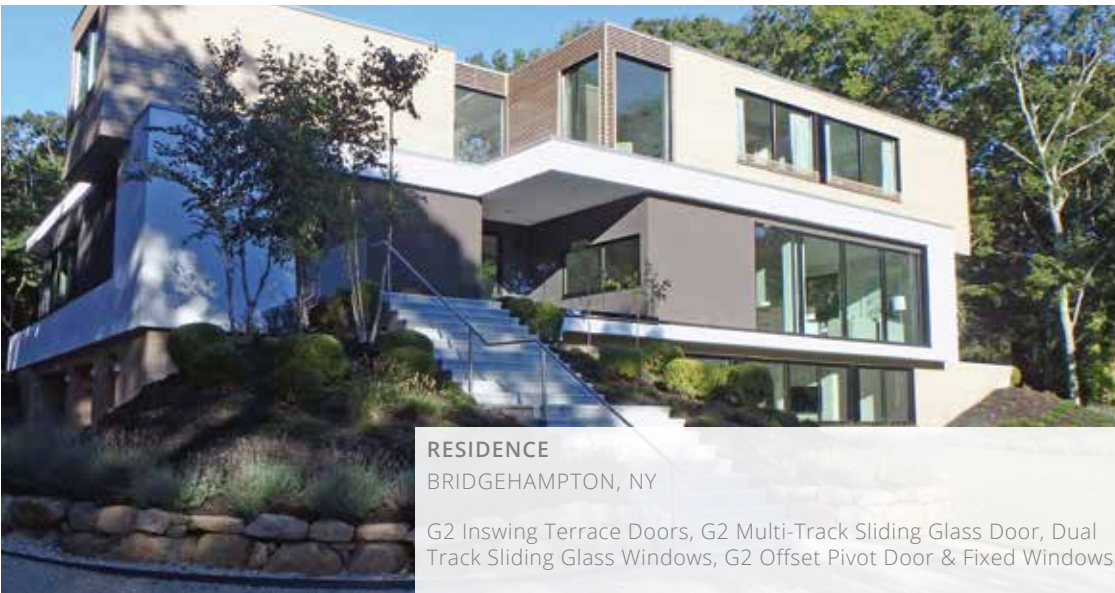

RESIDENCE
BRIDGEHAMPTON, NY

G2 Inswing Terrace Doors, G2 Multi-Track Sliding Glass Door, Dual Track Sliding Glass Windows, G2 Offset Pivot Door & Fixed Windows



RESIDENCE
ANNAPOLIS, MD

Aluminum Curtain Wall, G2 Folding Glass Walls, G2 Terrace Door & G2 Fixed Windows

Thermally Enhanced

A thermal break separates the aluminum and minimizes conductivity of heat and cold from the outside to the inside while ensuring the structure's interior remains comfortable all year long. Solar Innovations® offers two types of thermal break systems; Polyamide Strut and Pour and Debridge. In the first method, a polyamide strut is threaded into the cavity between two aluminum profiles and crimped into place. In the Pour and Debridge system, liquid polyurethane is poured into aluminum cavities that have been machined with an Azo-Brader, that allows for the polymer to mechanically lock in place. Both methods improve thermal efficiency by breaking the highly conductive properties of aluminum. Nonthermal aluminum frames should only be used for interior spaces or where thermal conductivity is not important.

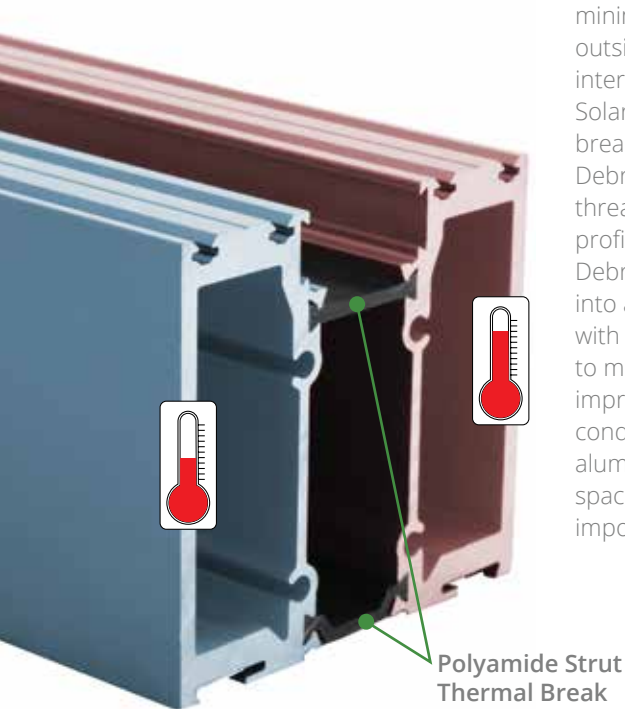

Polyamide Strut Thermal Break



High-Performance Glazing Unit

Pour and Debridge Thermal Break

Aluminum Frame

Certified Products

TESTING

Solar Innovations® is dedicated to providing safe, quality products to customers. Our in-house test labs offer the unique opportunity to execute tests quickly and efficiently with certification by nationally-recognized organizations.



NFRC Approved

- G2 Folding Glass Walls
- G2 Sliding Glass Door
- G3 Sliding Glass Door
- G3 Lift Slide Door
- G2 International Windows (Fixed, Casement, Awning, Tilt Turn)

HURRICANE IMPACT TESTED

We currently offer the largest selection of products certified by Florida rating organizations. They can withstand even the most extreme weather conditions.



- G2 Terrace Door
- G3 Terrace Door
- G2 Folding Glass Walls
- G3 Folding Glass Walls
- G2 Sliding Glass Door
- G3 Sliding Glass Door
- G3 Lift Slide Door
- G2 Aluminum Curtain Wall
- Wood Curtain Wall
- G2 International Windows (Fixed, Casement, Awning, Tilt Turn, Hopper)

Folding Glass Walls



RESIDENCE
NAPLES, FL

90° No Post G3 Folding Glass Wall



RESIDENCE
NEW YORK, NY
G2 Folding Glass Walls

Break Down the Walls

Folding glass walls have been a signature product of Solar Innovations® for over 15 years. Also known as bi-fold doors or accordion-style doors, folding glass walls can accommodate an unlimited number of panels and configurations. These systems offer a flexible and customizable opening that can be incorporated into any residential or commercial project including covered patios, living rooms, decks, enclosed porches, and pool houses. Swing doors can be integrated into the folding glass walls, allowing you to easily enter or exit a room without opening all of the panels. The endless possibilities — including custom color finishes, custom hardware, and the highest impact rating — make folding glass walls the perfect system for any application.

Component options are available on pages 38 - 46.

OPERATION

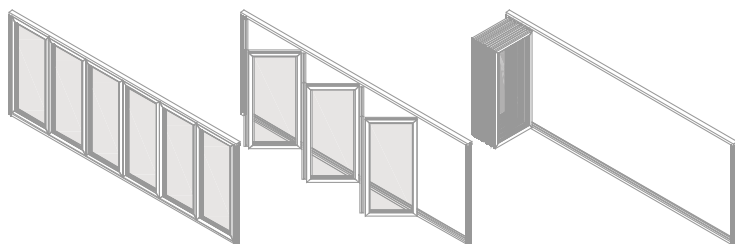

RESIDENCE
BONITA SPRINGS, FL
G2 Folding Glass Walls

Configurations

Custom configurations are available upon request.

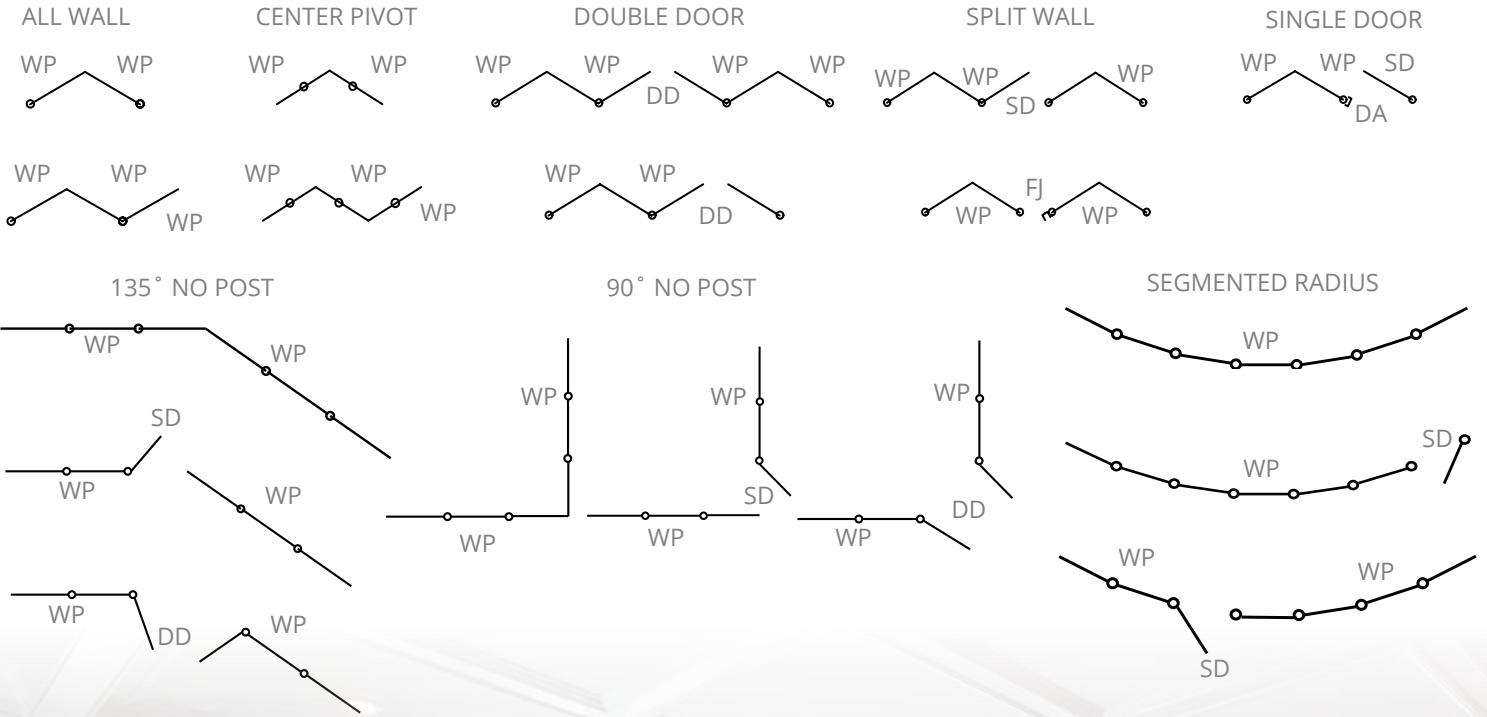

WP = Wall Panel SD = Single Door DD = Double Door DA = Door Adapter FJ = Floating Jamb



RESIDENCE
GREENWICH, CT
G2 Folding Glass Walls with
Integrated Swing Door

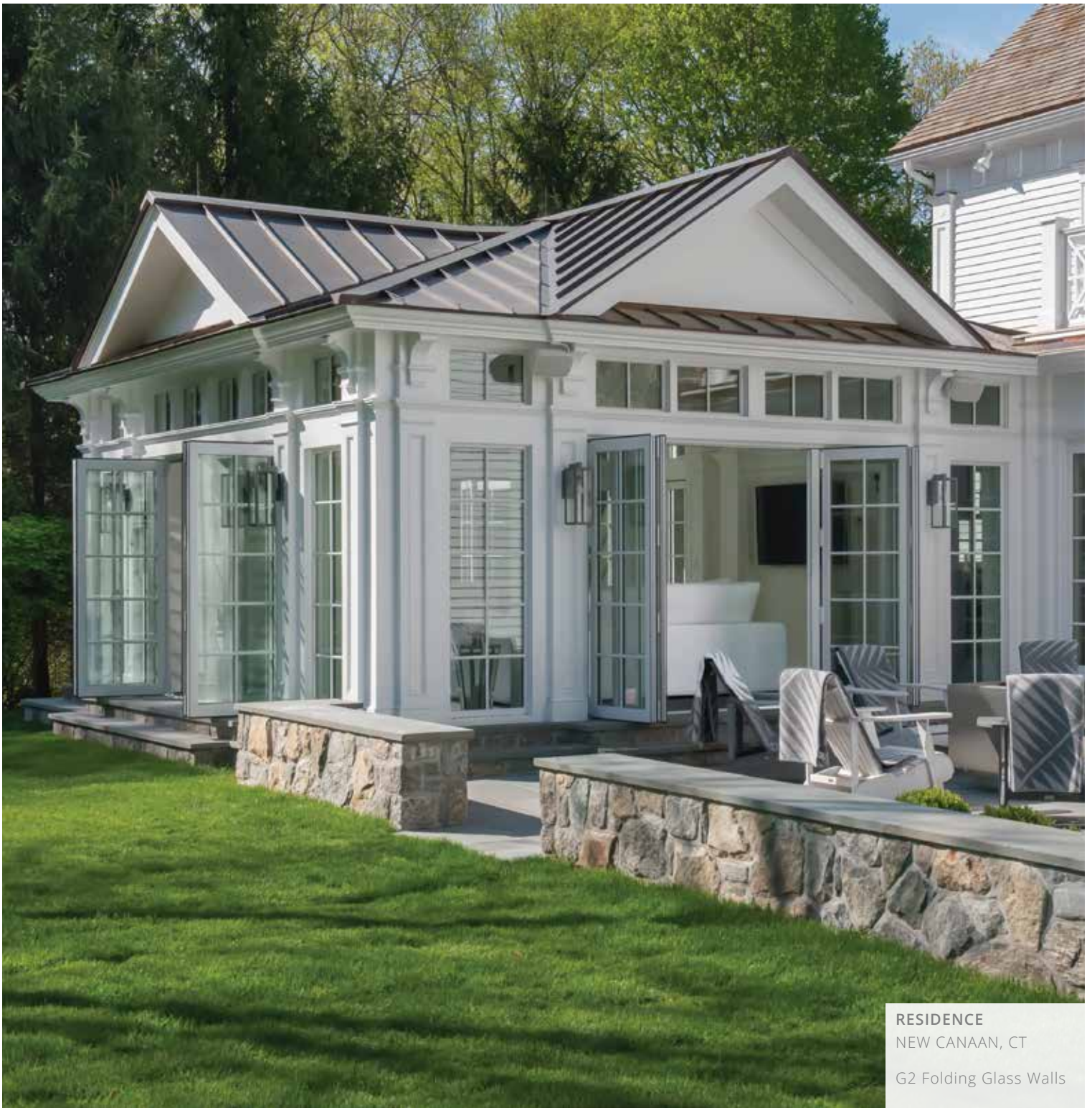

RESIDENCE
 NEW CANAAN, CT
 G2 Folding Glass Walls



PATENTED MARINE STOP GLAZED SYSTEM

Our G3 Extra Narrow Marine Glazed Folding Glass Wall System uses a patented design to combine vertical marine glazing with horizontal-stop glazing in order to create a much narrower vertical frame than conventional stop-glazed doors.

The G3 Extra Narrow Marine Glazed System is one of the narrowest four-sided thermally-broken glazed bi-fold doors in the market.



Slide & Stack Glass Walls



RESIDENCE
WICHITA, KS
G2 Slide & Stack Glass Walls

Create Transformative Living Spaces

Slide and stack glass wall systems feature individual panels that slide along a track from above and stack to a remote location or into a pocketed space within a home. This system is designed to accommodate a large number of panels that open to provide unobstructed views. Slide and stack glass walls offer an incredibly flexible and customizable opening that can be incorporated into any residential project, including covered patios, enclosed porches, and pool houses.

Component options are available on pages 38 - 46.

OPERATION



RESIDENCE
EPINA, MN

G2 Slide & Stack Glass Walls



RESIDENCE
POUND RIDGE, NY
G2 Slide & Stack Glass Wall



RESIDENCE
SPOKANE, WA
G2 Slide & Stack Glass Walls

Configurations

60° OFFSET STACK INDIVIDUAL PANELS



Straight Wall 60° Parallel Stack



Straight Wall 60° Parallel Stack with Integrated Door Panel



Straight Wall 60° Parallel Stack with Fixed Door Panel



Split Wall 60° Parallel Stack

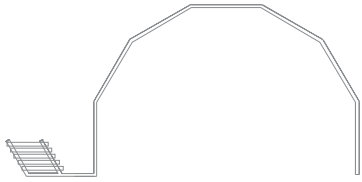

Segmented Radius 60° Perpendicular Stack

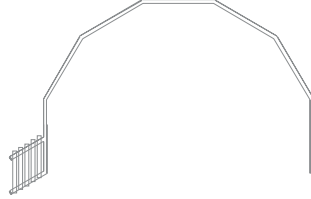

Segmented Radius 60° Parallel Stack

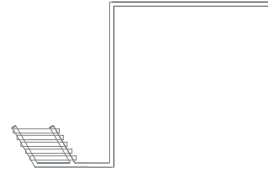

No Post Corner 60° Perpendicular Stack

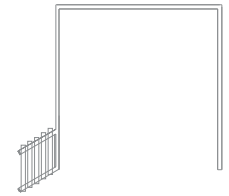

No Post Corner 60° Parallel Stack

90° OFFSET STACK INDIVIDUAL PANELS



Straight Wall Parallel Stack

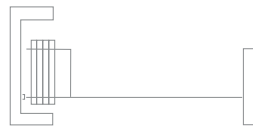

Straight Wall Perpendicular Stack



Straight Wall Parallel Stack with Fixed Door Panel



Straight Wall Perpendicular Stack with Fixed Door Panel

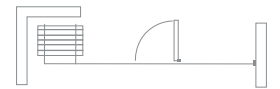

Straight Wall Parallel Stack with Integrated Door Panel

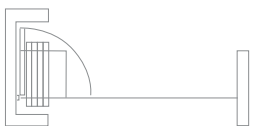

Straight Wall Perpendicular Stack with Fixed Door Panel

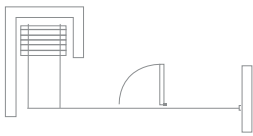

Straight Wall Parallel Remote Stack with Integrated Door Panel

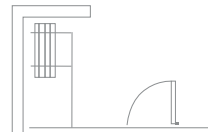

Straight Wall Perpendicular Remote Stack with Integrated Door Panel

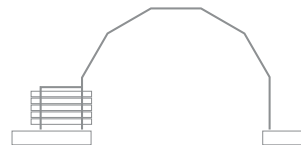

Segmented Radius Wall Parallel Stack



Segmented Radius Wall Perpendicular Stack



Segmented Radius Wall Parallel Stack

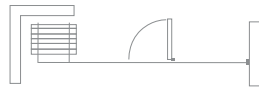

Straight Wall Parallel Remote Stack

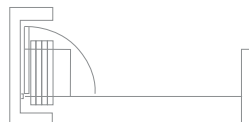

Offset Wall Parallel Remote Multi-Stack

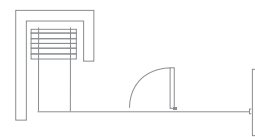

Corner Wall Perpendicular Remote Stack

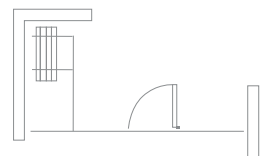

Corner Wall Perpendicular Stack

90° CENTER HUNG HINGED PAIRS



Straight Wall Perpendicular Stack

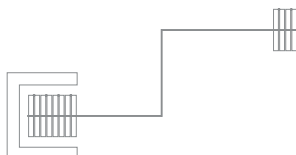

Offset Wall Perpendicular Stack



Segmented Radius Wall Perpendicular Stack

Lift Slide Doors



RESIDENTIAL APARTMENTS
HONOLULU, HI
Hurricane Rated Lift Slide Doors



RESIDENTIAL APARTMENTS
HONOLULU, HI
Hurricane Rated Lift Slide Doors



RESIDENCE
NEW CANAAN, CT
Lift Slide Doors

Practical and Completely Custom

Solar Innovations® Lift Slide Door Systems are a high-performance alternative to traditional sliding glass doors. Controlled with a simple turn of the wrist, the handle lifts the panels off the track to move with ease. This door can be opened with one hand and closed with even less resistance. Once the panels are in place, turning the handle reveals the door to provide security and superior air, water, and thermal performance.



BUILT TO PERFORM

The G3 Lift Slide Door System is NFRC certified, meeting the highest standards for energy efficiency, security, and durability. All air, water, and structural tests on the Lift Slide door system outperform the traditional sliding glass door system.

CONFIGURATIONS

Lift Slide Doors are available in dual and multi-track configurations and can feature pockets or 90° no-post corners. Custom configurations are also available; contact a Solar Innovations® sales designer for more information.

Component options are available on pages 38 - 46.

OPERATION

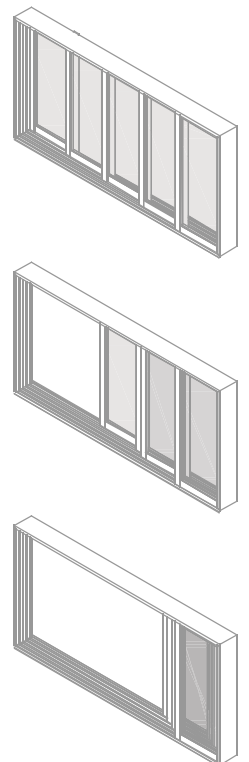

VERTICAL & HORIZONTAL RAIL OPTIONS

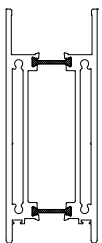

Bottom Rail

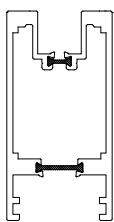

Handle Rail

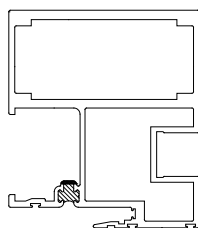

Hurricane Hook Rail

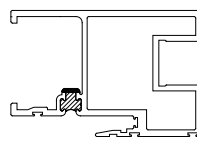

Hook Rail

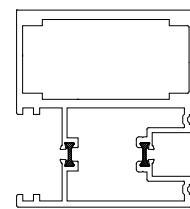

Hurricane Flush Rail

To download more details and dimensions, visit solarinnovations.com/information/downloads.

Sliding Glass Doors



RESIDENCE
SOUTHOLD, NY
G2 Multi-Track Sliding Glass Doors

Big Views Made Easy

Sliding glass door systems expand the view of any living space and can be used as external entryways or transitions between two interior spaces. Motorization options, pocketing possibilities, countless custom configurations, and expansive panel sizes make our sliding glass doors a flexible design element that complements any space. Where engineering allows, a pocket system can be added so the doors are completely hidden while open, creating an unobstructed view. Solar Innovations® also recommends the addition of a screen system for residential applications. There are many types of screens, including pet and insect screens.

Component options are available on pages 38 - 46.

OPERATION

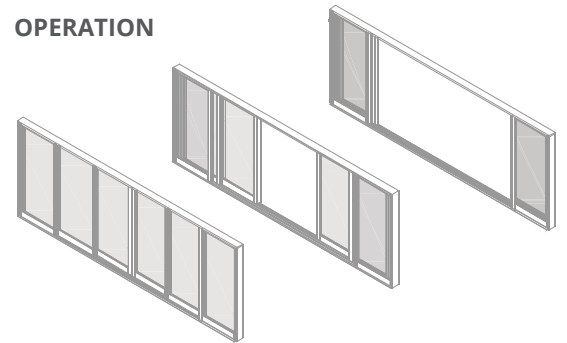

RESIDENCE
EAST HAMPTON, NY
G3 Multi-Track Sliding Glass Doors



CENTRALIA COLLEGE
CENTRALIA, PA
G3 Multi-Track Sliding Glass Doors

Configurations

The diagrams below represent just a fraction of the countless sliding glass door configurations.

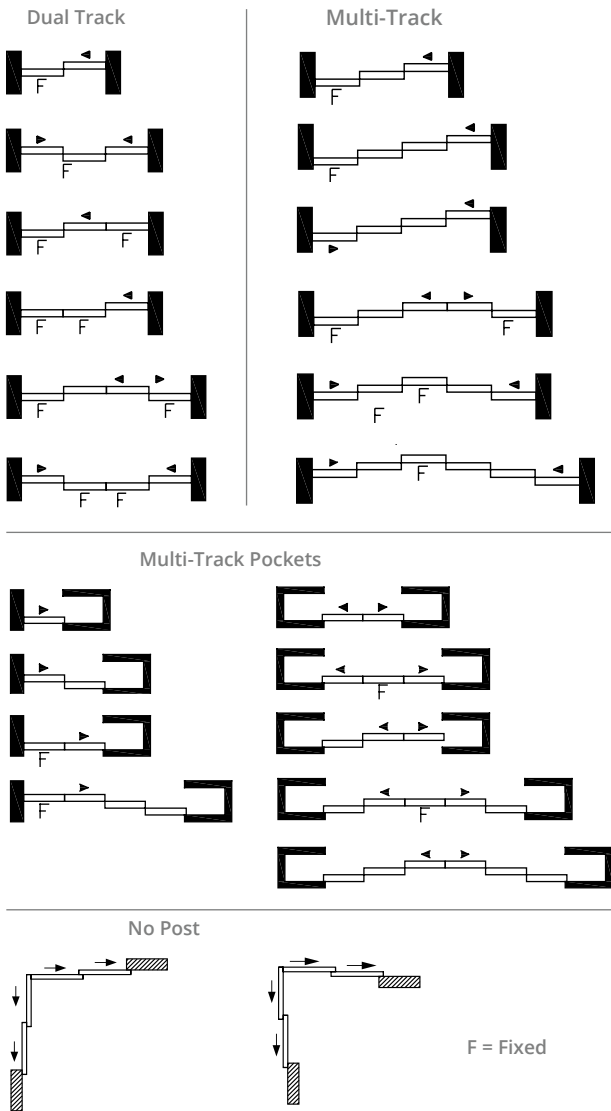

Details

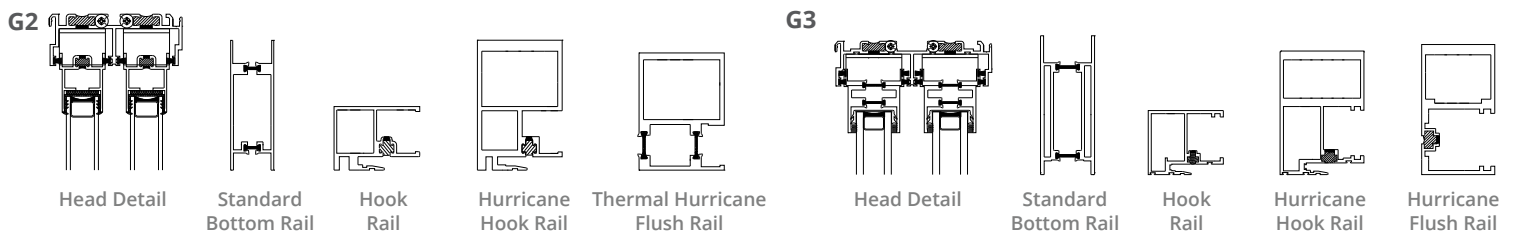

HURRICANE IMPACT TESTED

The G2 and G3 Impact Multi-Track Sliding Glass Door Systems are thermally enhanced, high-performance hurricane impact-rated doors. With all of the options of the G2 and G3 systems, the impact system is perfect for conditions that require high-performance fenestration solutions.



Pivot Doors



RESIDENCE
EAST HAMPTON, NY
G2 Offset Pivot Door



RESIDENCE
BRIDGEHAMPTON, NY
G2 Offset Pivot Door

Grand, Versatile Entryways

The search for oversized doors can be difficult, but Solar Innovations® offers the perfect solution. Pivot doors are ideal for oversized openings in interior and light exterior applications. Each door's pivot point is customizable, with center and off-center locations available. Pivot doors are equally suitable for residential and commercial applications and range from smaller scale doors to garage door sized openings. The large size openings and minimal floor space interruption allow for sizable items to pass through the framework that may be hindered by a traditional entrance. Our Pivot doors can be configured with a sill.

Component options are available on pages 38 - 46.

OPERATION



Configurations

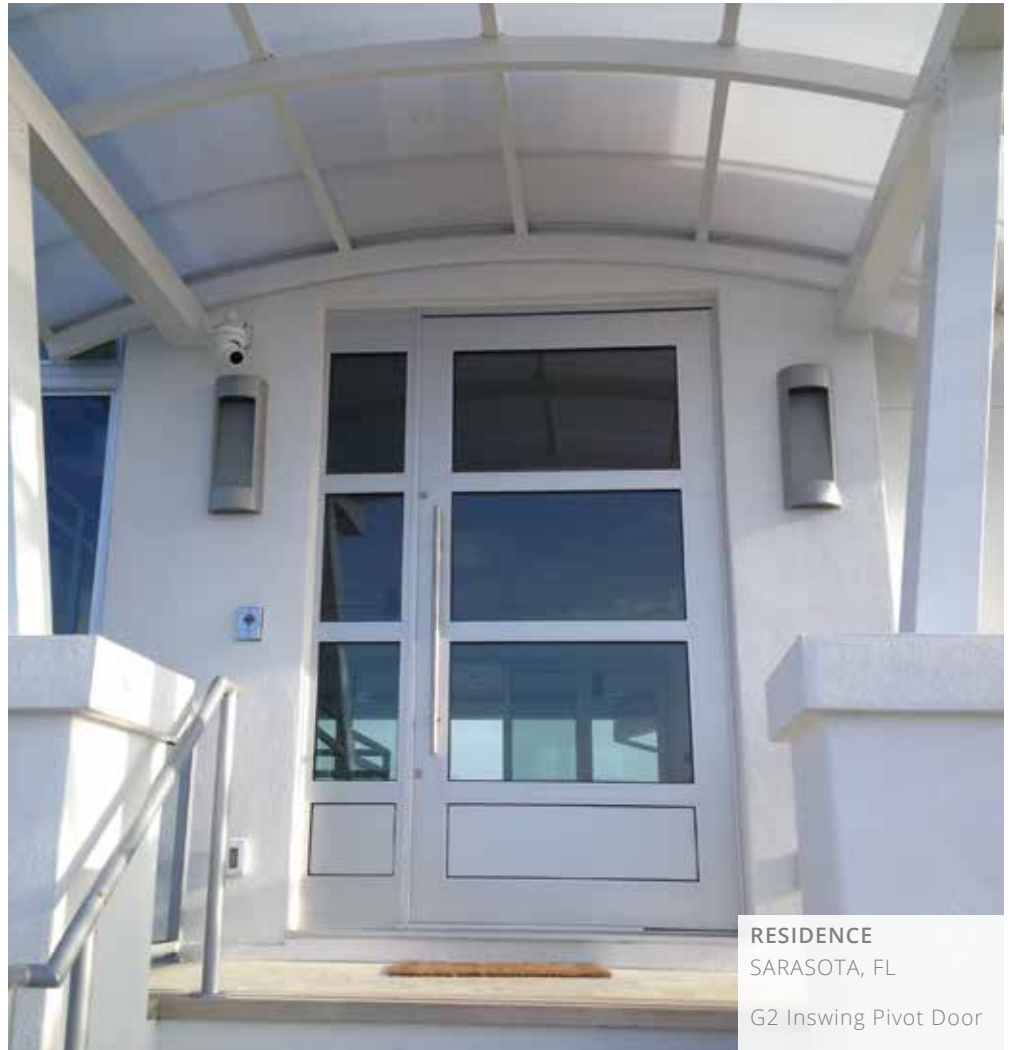
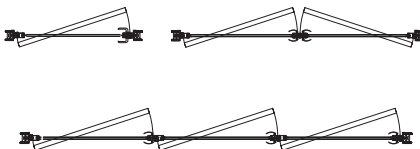

RESIDENCE
SARASOTA, FL
G2 Inswing Pivot Door

Clear Glass Walls



SHARPE BUILDING AT THE FOUNDRY
PROVIDENCE, RI

Slide & Stack Clear Glass Wall with
Integrated Pivot Door

Seamless Walls with Uninterrupted Views

Clear glass walls eliminate vertical stiles, allowing for maximum transparency, natural daylighting, open views, and a sleek, modern appearance. The systems' nonthermal designs make them a great choice for interior room dividers and exterior applications with overhead protection. Our Clear Glass Wall systems can be assembled in a slide and stack, sliding or folding manner and aren't limited to the number of panels.

Component options are available on pages 38 - 46.

Details

FOLDING CLEAR GLASS WALLS

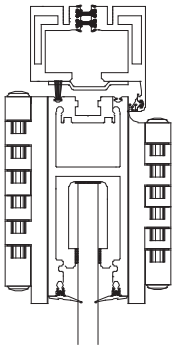

SLIDE & STACK CLEAR GLASS WALLS

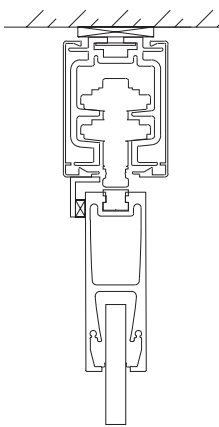

SLIDING CLEAR GLASS WALLS

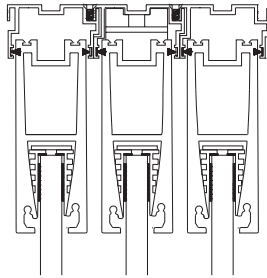

OPERATION

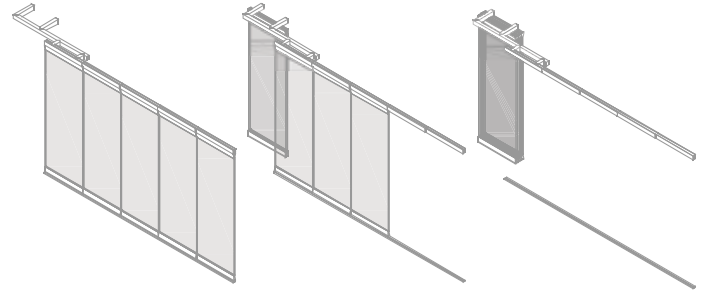

SLIDING GASKETS

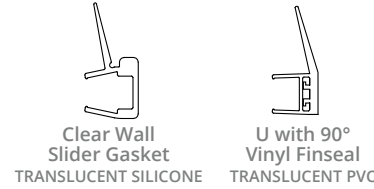

FOLDING GASKETS



SLIDE & STACK GASKETS

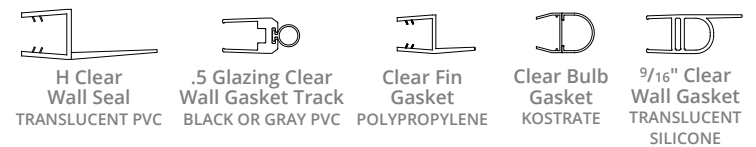

To download more details and dimensions, visit solarinnovations.com/information/downloads.



KENT STATE UNIVERSITY
KENT, OH
Slide & Stack Clear Glass Wall

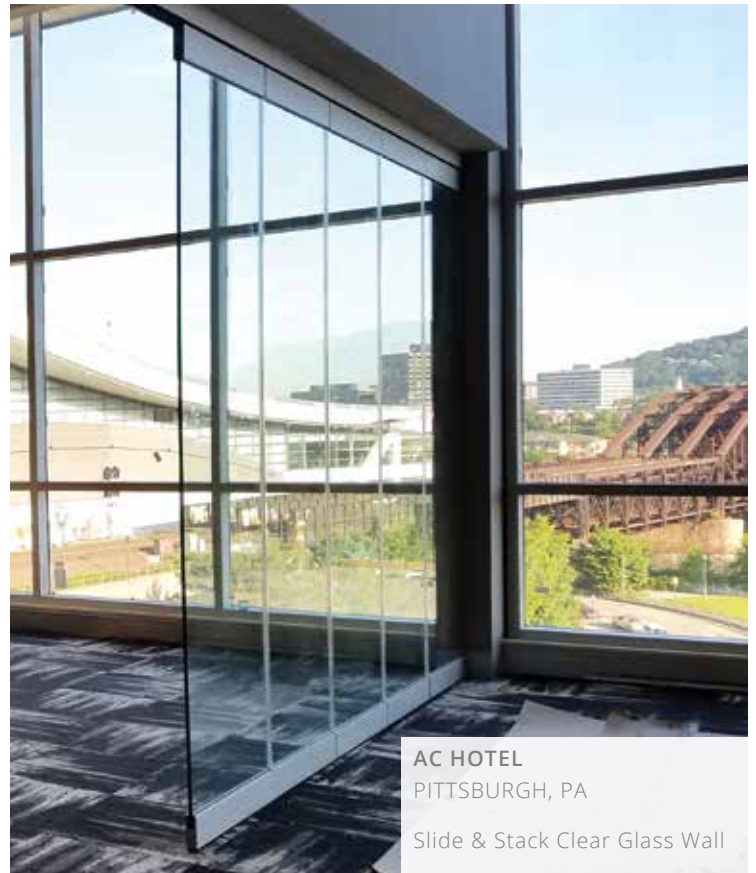

AC HOTEL
PITTSBURGH, PA
Slide & Stack Clear Glass Wall

Swing Doors



RESIDENCE
SOMERVILLE, MA
G2 Outswing French Doors



RESIDENCE
TRURO, MA
G2 Outswing Terrace Door

Flexible and Durable Entryways

While swing doors may be one of the simplest and most common door systems, they should not be overlooked when designing and planning a space. Choose from a large offering of side-hinged swing door options, including terrace, and French doors. With numerous custom decorative glazing options, finishes, matching sightlines, and transoms, our swing doors can fit any need. The doors can blend in with the aesthetics of a surrounding structure, act as utilitarian entrances, or can be the star of the show with the grandeur of a true entry door. Swing doors feature similar panel and hardware designs as Solar Innovations® operable walls and structures, creating a consistent appearance throughout your project.

TERRACE & FRENCH DOORS

Terrace doors, or single swing doors, are a single panel opening used in both internal and external applications. French doors, also known as dual swing doors or double-swing doors, consist of two panels that close in the center. French doors do not require framing between the two panels, providing an unobstructed opening. The unique mulling capabilities allow for modular construction. Transoms and sidelites can also be seamlessly integrated into the design. Terrace and French doors can be either inswing or outswing. These systems can also be integrated into our folding glass walls and slide and stack glass wall systems.



HEAD & SILL DETAILS

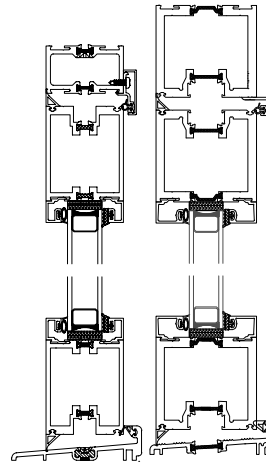

G2 Outswing G3 Outswing

Component options are available on pages 38 - 46.

OPERATION

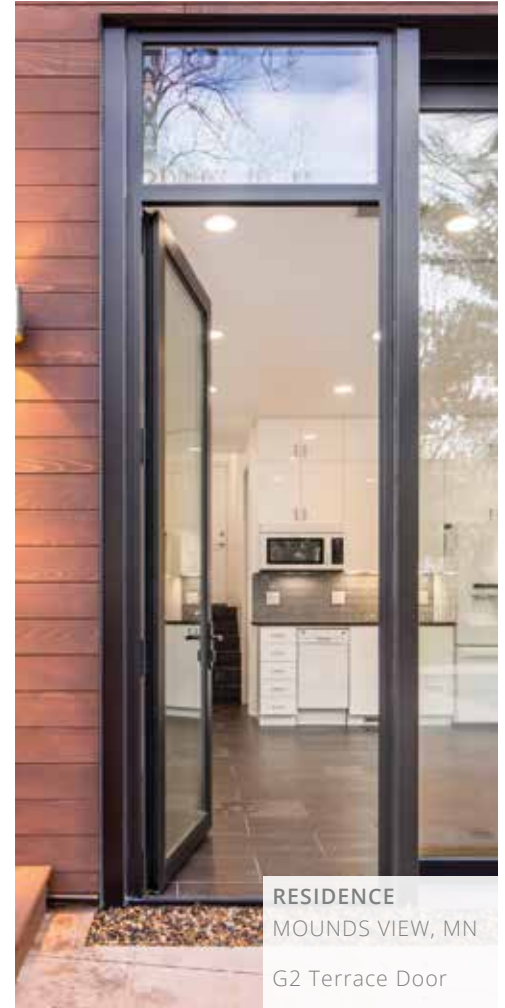
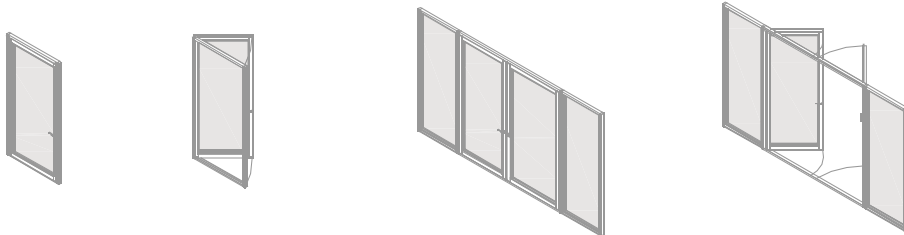

RESIDENCE
MOUNDS VIEW, MN
G2 Terrace Door

Configurations

TERRACE DOOR

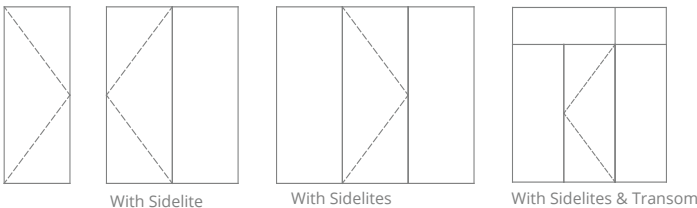

FRENCH DOOR

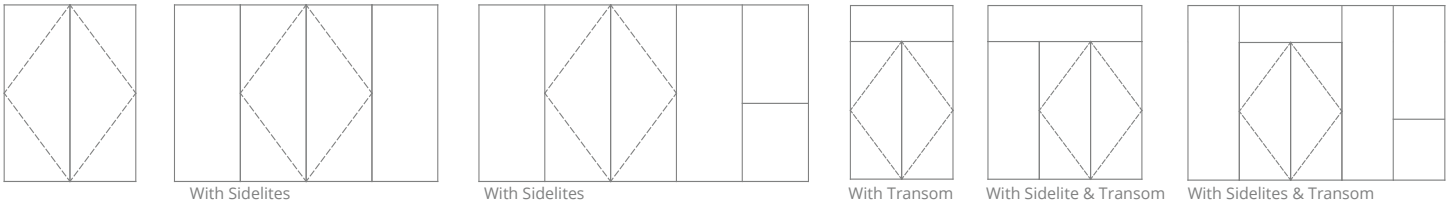

To download more details and for dimensions, visit solarinnovations.com/information/downloads.

Window Systems

With a broad range in window operations — from fixed to tilt-turn — Solar Innovations® window systems offer countless custom configurations to enhance any living space. The thermally-broken aluminum profiles have exceptional thermal performance, creating a comfortable environment in all temperature extremes. In addition, aluminum windows will not rust, rot, warp, or require constant finish maintenance.

CASEMENT WINDOWS

Casement windows are one of the most popular styles in the world. They are hinged at the side and swing outward when opened. Casement windows are excellent for natural ventilation, especially in hot climates. Inswing casement windows are also available.



AWNING WINDOWS

Awning windows hinge at the top of the frame, allowing the bottom to open outward. There is usually a cam lock on the interior, which can be unlocked, allowing the window to open. They are a popular choice for in-system windows in greenhouses, conservatories, sunrooms, and other glass structures. When the windows are open, rain water will flow off and away from your structure.



HOPPER WINDOWS

Hopper windows are hinged at the bottom and tilt in to offer increased ventilation. They are often paired with other fixed or operable windows and doors or incorporated into transoms. These window systems are typically used in basements for light and ventilation where there is limited space.



TILT-TURN WINDOWS

Tilt-turn windows offer dual action with the turn of a handle. Turning the handle upward allows the window to open like a hopper, offering increased security. Turning the handle to the side opens it like an inswing casement, allowing for easy cleaning. Returning the handle downward engages the lock.

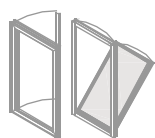

FIXED WINDOWS

Fixed windows are non-operable, meaning they can't be opened. This type of window is often found in conjunction with the other types of windows in a mulled window system or in areas where natural light is needed without the need for ventilation.



Component options are available on pages 38 - 46.



RESIDENCE
QUEENSTOWN, MD
Mulled Window System
with Casement Windows



RESIDENCE
DENVER, CO
Casement & Fixed Windows

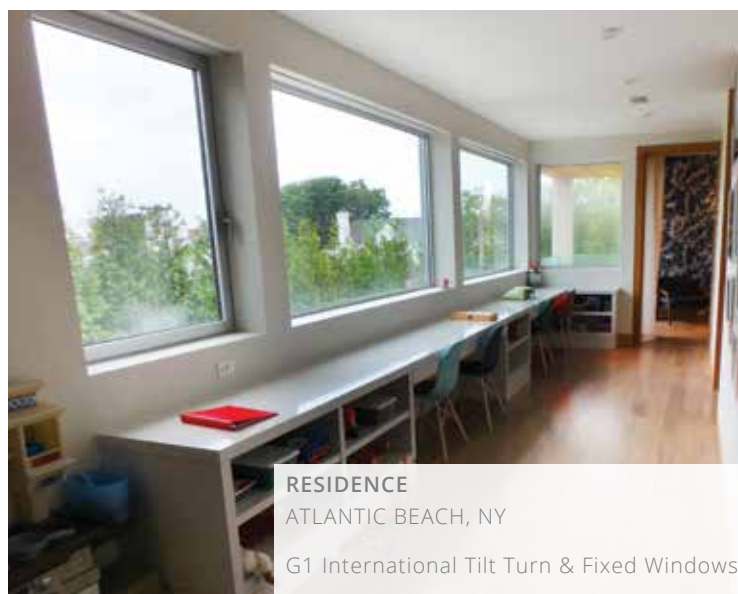

RESIDENCE
ATLANTIC BEACH, NY
G1 International Tilt Turn & Fixed Windows



RESIDENCE
SOUTHOLD, NY
G2 International Fixed, Awning, Casement & Tilt Turn Windows

Mulled Window System

A Muller Window System combines multiple panels into one unit. It can consist of all fixed-panel windows or be combined with awning, hopper, and casement operable windows. Unlike the systems from many other manufacturers, our Muller Window System can include both inswing and outswing windows within one unit, creating a truly unique and customizable system.

PERFORMANCE

- Water performance up to 15psf (fixed), depending on configuration, and water column.
- Higher design pressure ratings available with engineering approval.
- Test results available upon request.

PANEL SIZES

- Minimum panel size: 2' x 2' operable, 1' x 1' fixed; smaller panels may be available upon engineering approval.
- Maximum panel size up to 4' x 8' subject to hardware limitations; larger panel options may be available depending on application.

Component options are available on pages 38 - 46.

To download more details and dimensions, visit solarinnovations.com/information/downloads.

Head & Sill Details

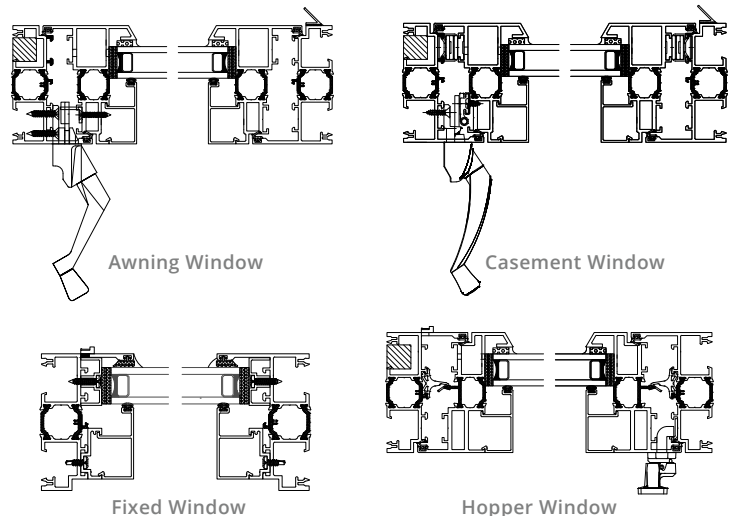

G1, G2, G3 International Systems

G1 INTERNATIONAL SYSTEM

The G1 International Window System is a smaller version of our existing Muller Window System. The G1 Window System utilizes thermal strut technology to maximize thermal performance. Beveled exterior edges provide a more traditional look compared to the G2 and G3 Window Systems' modern sightlines. This system is the best for traditional grid systems and two tone applications.

G2 INTERNATIONAL SYSTEM



With the ability to mull different operable or fixed windows together, the G2 International Window Systems allow almost any type of configuration imaginable while providing superior thermal and structural performance. This system utilizes fill and debridge technology. Casement, awning, fixed, and hopper windows can be incorporated into the same unit without requiring additional framing in this system. Large, high-performance tilt-turn windows utilize the G2 HP System.

G3 INTERNATIONAL SYSTEM

G3 International Window Systems provide superior thermal offerings and capabilities by utilizing a thermal strut. This technology allows for a dual color unit by separating the profiles into two individual pieces. It also provides a wide range of glazing thicknesses to conform to any application. This system can incorporate awning, hopper, casement, fixed, and tilt-turn windows.

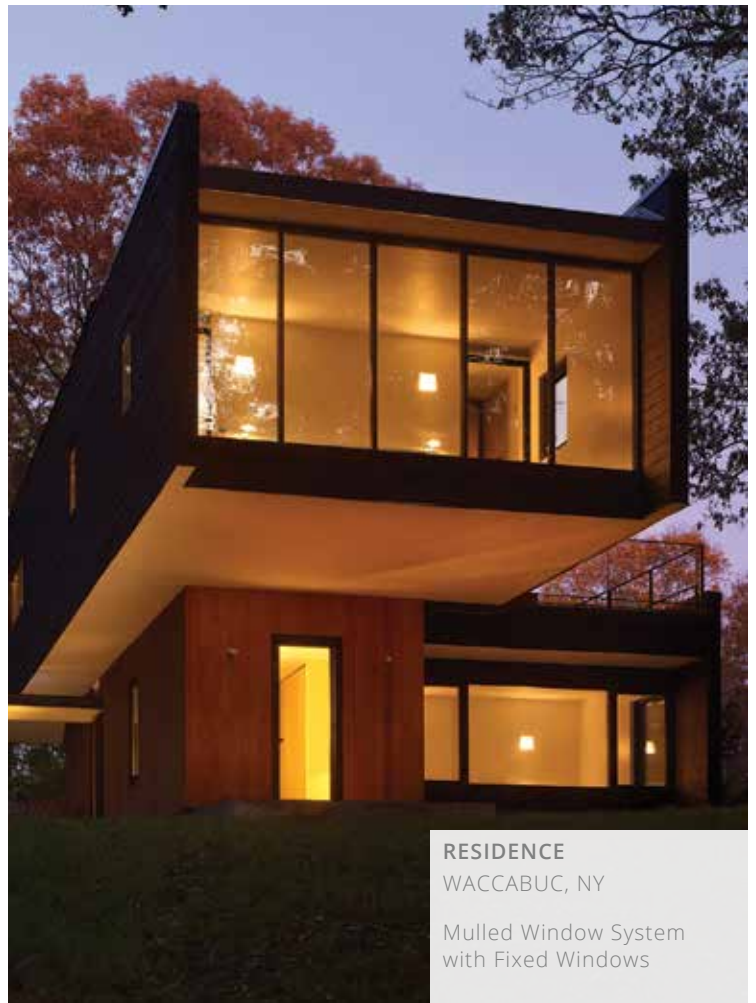

RESIDENCE
WACCABUC, NY

Muller Window System
with Fixed Windows

Casement Window Crank Details

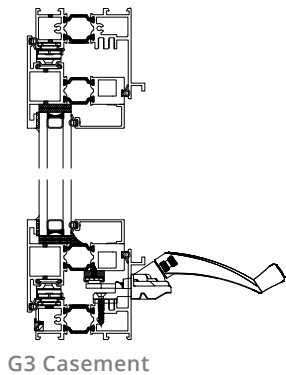
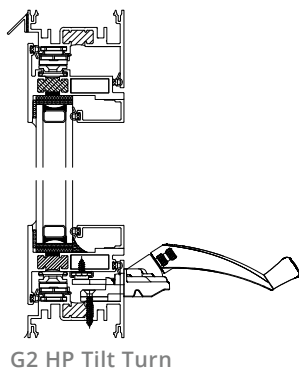
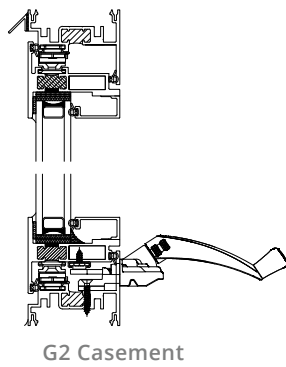
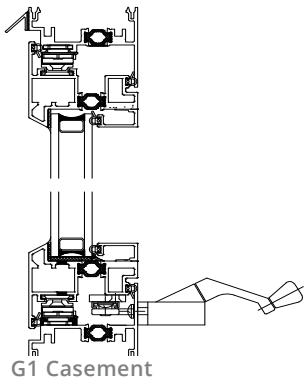

RESIDENCE
ALBURTIS, PA

G1 International Awning,
Hopper & Fixed Windows

To download more details and dimensions, visit
solarinnovations.com/information/downloads.

Wood Curtain Walls

Warm Wood Interior, Uncompromising Aluminum Exterior

Wood curtain walls, or timber walls, innovatively combine the warmth and beauty of a natural wood interior with the durability and longevity of an aluminum exterior to create the perfect solution for those seeking a high-performing, sustainable building system. An exterior aluminum system creates a superior barrier from the elements, limiting the wood's exposure to any type of precipitation or wind, and dependably maintains a high level of performance through positive drainage principles. By overlapping the horizontal profiles with the vertical profiles, our wood curtain wall is a pressure-equalized system. The lack of obstruction from horizontal to vertical is the key component to pressure equalization.

Component options are available on pages 38 - 46.



DESIGN OPTIONS

In addition to Solar Innovations® wood interior/aluminum exterior system, we also offer a variety of design options for a truly custom wood curtain wall. For an all-wood style, a wood cover-cap can be used for the exterior in sheltered situations. Structurally-glazed options allow for a flush exterior with no caps.



Wood Facade System
(Standard Option)



Wood Facade with Wood Cover Cap
(Available for interior walls/sheltered walls)



2-Sided Structurally Glazed Wood Facade



4-Sided Structurally Glazed Wood Facade



Wood and Aluminum Facade System

Wood/Glulam Standard Type



White Oak Red Oak Hard Maple White Ash

Wood/Glulam Designer Type



Cherry Douglas Fir Sapele Mahogany Walnut

Additional wood types, including Eastern White Pine, are also available.

Glue Laminated Timber Option

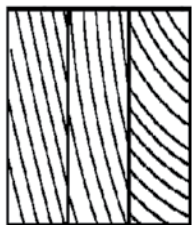

Traditional Glue Laminated Timber

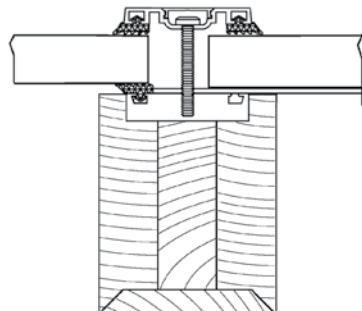

U.S. Patent 9,441,373 Glue Laminated Timber

Solar Innovations® patented Glue laminated timber simulates the appearance of solid sawn wood. The glulam can be utilized as both a structural and aesthetic element for glass doors and windows as well as other structural applications where thick solid furniture-grade exotic hardwood can be utilized and can be difficult to obtain. The lams are stacked along the length of the glulam providing a solid wood outer surface as the widest surface of the glulam. At least one lam is stacked transversely and inset to form the appearance of a solid wood surface and cover lamination seams.



Aluminum Curtain Walls



RESIDENCE
CARLISLE, MA
Aluminum Curtain Wall

Even More Natural Light

Curtain walls are an excellent way to bring natural light into a room while remaining protected from the elements. Many providers often shy away from unique curtain wall projects that integrate canopies, doors, windows, and sloped glazing, but unique applications are where Solar Innovations® excels. We can work with you to identify the right concept for your location. Being one of the most experienced manufacturers, we offer the best thermally-enhanced system for custom curtain walls and window-wall applications.

Component options are available on pages 38 - 46.

REGULAR GLAZING BAR CURTAIN WALL CAP GLAZED

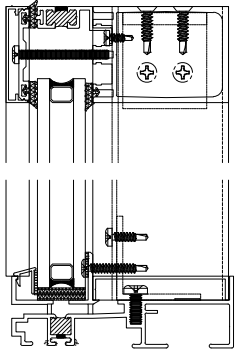

Head & Sill Detail

REGULAR GLAZING BAR CURTAIN WALL 4-SIDED STRUCTURALLY GLAZED

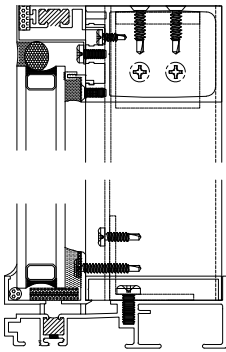

Head & Sill Detail

Configurations

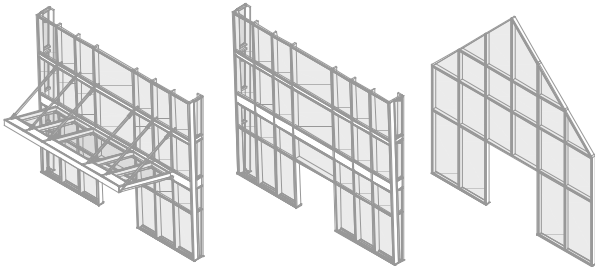

To download more details and for dimensions, visit solarinnovations.com/information/downloads.



RESIDENCE
BROOKLYN, NY

Aluminum Curtain Wall with G2 Multi-Track Sliding Glass Doors & Awning Windows



RESIDENCE
ST. LOUIS, MO

Aluminum Curtain Wall with G2 Dual Track Sliding Glass Door

System Comparison

G2 ALUMINUM



G3 & G3 LITE ALUMINUM



System	Material	Maximum panel size*	NFRC approved	Energy efficiency	Acoustical	Impact rated	System wall depth	Top or bottom load
Folding Glass Wall	G2 aluminum	3' x 10'	Yes	Better	Varies with options selected	Yes	2¼"	Both
	G3 & G3 lite aluminum	3' x 15'	Pending	Better	Varies with options selected	Yes	3"	Both
	Aluminum with wood cladding	3' x 15'	Pending	Best	Varies with options selected	Yes	Varies with options selected	Both
	Wood	3' x 10'	Pending	Best	Varies with options selected	No	3"	Both
Slide & Stack Wall	G2 aluminum	3' x 10'	No	Better	-	No	2¼"	Top
	G3 & G3 lite aluminum	4' x 16'	No	Best	Varies with options selected	No	3"	Top
	Aluminum with wood cladding	5' x 12'	No	Better	-	No	Varies with options selected	Top
	Wood	5' x 10'	No	Best	-	No	3"	Top
Sliding Door	G2 aluminum	5' x 10'	Yes	Better	Varies with options selected	Yes	Varies with options selected	Bottom
	G3 & G3 lite aluminum	5' x 15'	Yes	Best	Varies with options selected	Yes	Varies with options selected	Bottom
Lift Slide	G3 aluminum	5' x 15'	Yes	Best	Varies with options selected	Yes	Varies with options selected	Bottom
Pivot	G2 aluminum	5' x 10'	No	Better	-	No	2¼"	Bottom
	G3 & G3 lite aluminum	6' x 12'	No	Best	-	No	3"	Bottom
Swing Door	G2 aluminum	3½' x 10'	Yes	Better	Varies with options selected	Yes	2¼"	NA
	G3 & G3 lite aluminum	5' x 15'	Yes	Best	Varies with options selected	Yes	3"	NA
	Aluminum with wood cladding	5' x 12'	-	Best	Varies with options selected	-	3"	NA
	Wood	5' x 10'	-	Best	Varies with options selected	-	Varies with options selected	NA

* Custom configurations, oversized panels, and variations are available with engineering approval. Please contact a Solar Innovations® sales designer to discuss options.

** Water performance depends on sill type, outfold vs. infold, configurations and up-leg height.

*** AAMA 2603-04-05 custom options are also available.

**** Can also be laminated, veneered, or custom painted.

**ALUMINUM
WITH WOOD
CLADDING**



WOOD



Stock finishes	Grids	Glazing infill	Maximum number of panels	Water performance**	Closer options
White, Bronze, Clear Anodized, Dark Bronze Anodized***	Yes	3/16" - 1 1/4"	20	Up to 15psf	NA
White, Bronze, Clear Anodized, Dark Bronze Anodized***	Yes	1/4" - 1 1/2"	20	Up to 12psf	NA
White, Bronze, Clear Anodized, Dark Bronze Anodized***	Yes	3/16" - 1 1/2"	20	Up to 12psf	NA
White Oak, Red Oak, Hard Maple, White Ash	Yes	3/16" - 1 1/2"	15	Up to 12psf	NA
White, Bronze, Clear Anodized, Dark Bronze Anodized***	Yes	3/16" - 1 1/4"	Unlimited (Based on engineering requirements)	-	NA
White, Bronze, Clear Anodized, Dark Bronze Anodized***	Yes	1/4" - 1 1/2"	Unlimited (Based on engineering requirements)	-	NA
White, Bronze, Clear Anodized, Dark Bronze Anodized***	Yes	1" - 1 1/2"	Unlimited (Based on engineering requirements)	-	NA
White Oak, Red Oak, Hard Maple, White Ash	Yes	1" - 1 1/2"	Unlimited (Based on engineering requirements)	-	NA
White, Bronze, Clear Anodized, Dark Bronze Anodized***	Yes	3/16" - 1 1/16"	10 - manual (motorized available)	6.0psf - 12.0psf	NA
White, Bronze, Clear Anodized, Dark Bronze Anodized***	Yes	1 1/4" - 1 3/8"	10 - manual (motorized available)	6.0psf - 12.0psf	NA
White, Bronze, Clear Anodized, Dark Bronze Anodized***	Yes	1 1/4" - 1 3/8"	10 - manual (motorized available)	12.0psf and higher	NA
White, Bronze, Clear Anodized, Dark Bronze Anodized***	Yes	3/16" - 1 1/4"	Unlimited (Based on engineering requirements)	-	Floor & head
White, Bronze, Clear Anodized, Dark Bronze Anodized***	Yes	1/4" - 1 1/2"	Unlimited (Based on engineering requirements)	-	Floor & head
White, Bronze, Clear Anodized, Dark Bronze Anodized***	Yes	3/16" - 1 1/4"	NA	6.0psf (Up to 12.0psf with high performance sill)	NA
White, Bronze, Clear Anodized, Dark Bronze Anodized***	Yes	1/4" - 1 1/2"	NA	6.0psf (Up to 12.0psf with high performance sill)	NA
White, Bronze, Clear Anodized, Dark Bronze Anodized***	Yes	3/16" - 1 1/2"	NA	6.0psf	NA
White Oak, Red Oak, Hard Maple, White Ash	Yes	1"	NA	6.0psf	NA

Finish Options



RESIDENCE
EAST HAMPTON, NY
G2 & G3 Multi-Track Sliding Glass Doors & Fixed Windows



RESIDENCE
SARASOTA, FL
G2 Folding Glass Walls & G2 Sliding Glass Windows

Finish Options

Paint AAMA 2603 (5 year warranty). Finishes available while in stock.

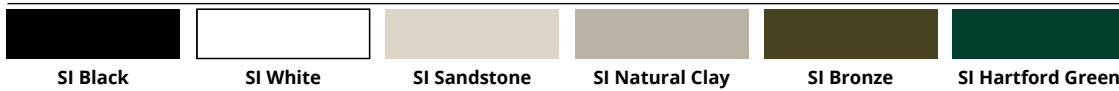

Anodized Additional cost



Powder Coat Solids STANDARD - AAMA 2605 (10 year; up to 20 year warranty). Scratch & fade resistant; contains no VOCs.*



Powder Coat Solids PREMIUM - AAMA 2605 (10 year; up to 20 year warranty). Scratch & fade resistant; contains no VOCs.*

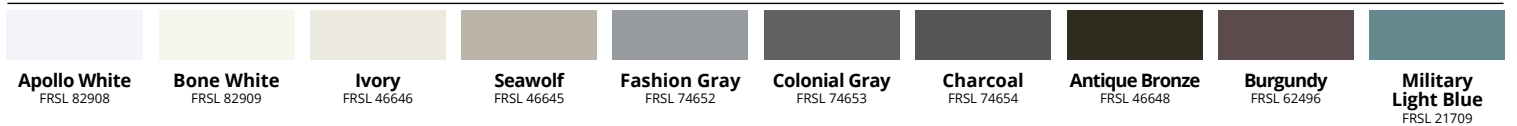

Visit <https://www.ifscoatings.com/content/assets/Uploads/brochures/IFS-Architectural-Digital-Color-Card.pdf> for additional metallic and anodic finishes.

Metal Clad STANDARD* (EXTERIOR ONLY)



Metal Clad PREMIUM*



Decoral Finishes (Powder Coat)*

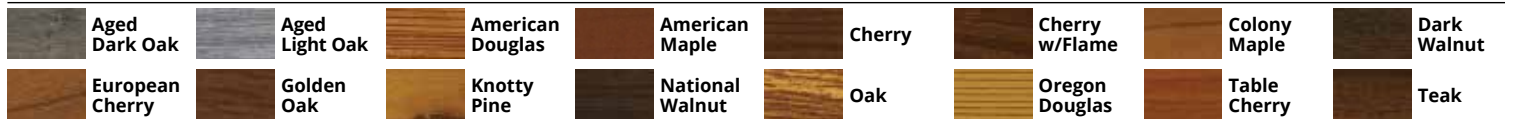

Wood Veneering (Unfinished) STANDARD*



Wood Veneering (Unfinished) PREMIUM*



Note: wood veneering is for interior applications only. Available on a limited basis due to vendor supply.

Wood/Glulam STANDARD*

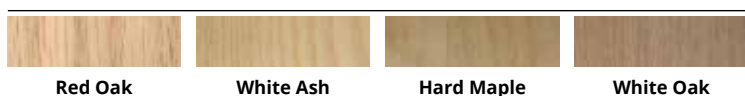

Wood/Glulam PREMIUM*



*Lead times subject to availability. ** Special order.

Note: Depending upon color selection, additional charges and increased lead times may apply. Extended warranties and service plans are available for an additional charge. Examples are shown as accurate as photography and printing processes allow. Final finish selection should be made from a physical sample; contact Solar Innovations® for samples. Product and finish options are subject to vendor availability. Solar Innovations® reserves the right to discontinue any option at any time without notice. Additional options, including custom color match, are available; contact Solar Innovations® for details.

Choosing the Right Frame

G2 SYSTEM



G2 systems are a great way to open your environment. The frame uses a thermal strut system that separates the interior metal from the exterior metal. By including a thermal break, the temperature transfer between the outdoors and indoors is minimized. The frames are available in two vertical stile widths: narrow and standard. The widths can be combined over multiple units for a unique style or kept consistent throughout. Standard, narrow, and wide mullions are also available.

G2

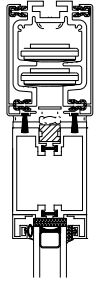

Head Detail

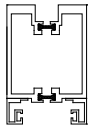

Standard Thermal

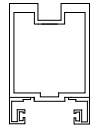

Standard Nonthermal

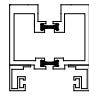

Narrow Thermal

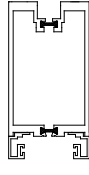

Stretch Rail



Heavy Thermal



10" Bottom Rail

G3 SYSTEM

G3 systems are designed for residential and commercial applications that require higher design pressures. This system has been designed to support larger sizes with ease of operation and offers exceptional air, water, structural, and thermal performance. The G3 Nonthermal System is ideal for applications that do not require thermal performance, including mild climates and indoor uses—this system is popular for interior entryways and room dividers. Standard, narrow, and wide mullions are also available. The G3 Thermal System achieves both exceptional structural and thermal performance.

G3

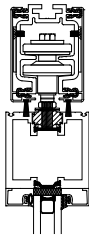

Head Detail



Standard Thermal



Standard Nonthermal

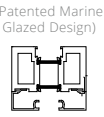

Narrow Thermal
(Patented Marine Glazed Design)

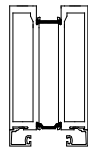

Stretch Rail

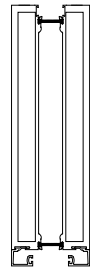

10" Bottom Rail



PAYCHEX SAWGRASS PAVILION
ROCHESTER, NY

G2 Nonthermal Folding Glass Walls

Hardware Options

SWING, PIVOT, SLIDE & STACK DOOR, AND FOLDING GLASS WALL HARDWARE

Handles

BRASS — INLAND APPLICATIONS



ALUMINUM — INLAND APPLICATIONS



ARCHITECTURAL DOOR PULLS



SOLID BRASS — COASTAL APPLICATIONS

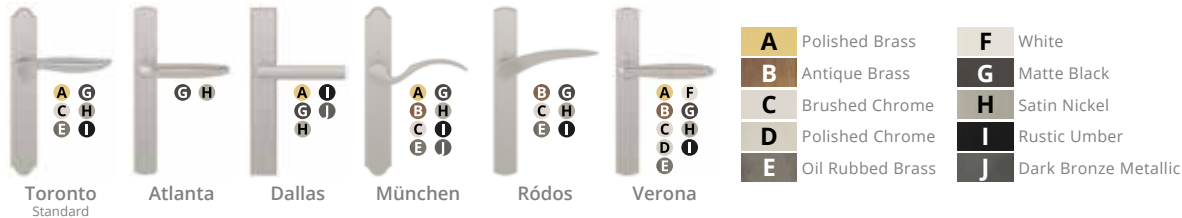

CONTEMPORARY



Locks



Hinges



Closers, Catches, & Limiters



Commercial Hardware

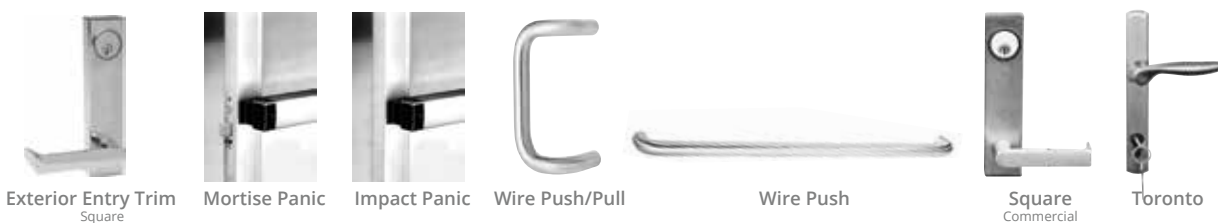

Please Note: All hardware is subject to vendor availability. Custom finishes may be available upon request at additional lead times and/or cost. Solar Innovations® reserves the right to discontinue any hardware option at any time. Please visit solarinnovations.com for additional product information.

CLEAR GLASS WALL HARDWARE



Swing Door Handles

For Integrated Doors in Slide & Stack and Folding Systems



Clear FGW Hinge
For Folding Systems



Thumbturn Bottom Lock



Keyed Bottom Lock



Glass-Mounted Pull Handle
For Sliding Systems

SLIDING GLASS DOOR HARDWARE



Ergonomic



Locking Option

Recessed Flush Lock



No Lock Option

Recessed Flush Lock



Edge Pull
(Pocket Doors Only)



Recessed Thumbturn

LIFT-SLIDE DOOR HARDWARE



Atlanta



**Athinai/
Finger Grip**



**Tokyo/
Finger Grip**



Finger Grip

Sill Options

FGW = Folding Glass Wall
SS = Slide & Stack Glass Wall

LS = Lift Slide Door
SG = Sliding Glass Door

PD = Pivot Door
CGW = Clear Glass Wall

SD = Swing Door

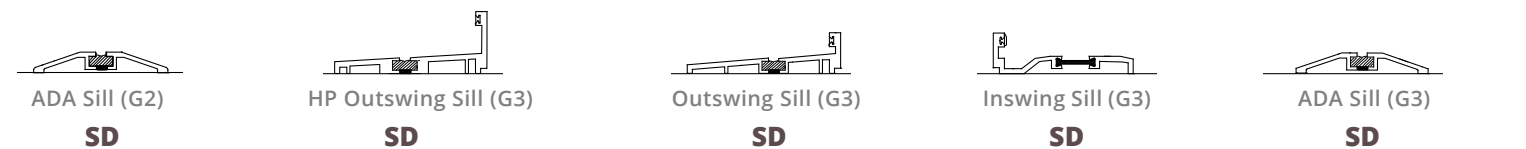
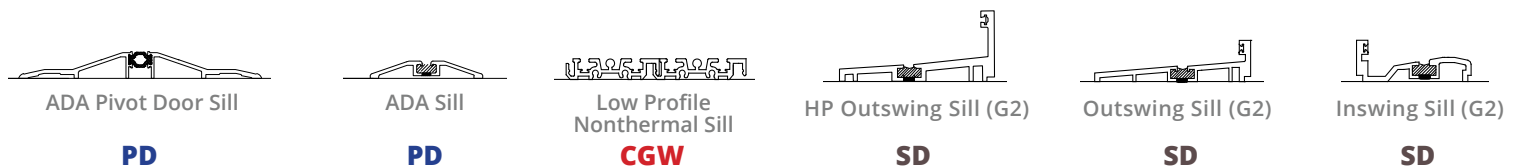
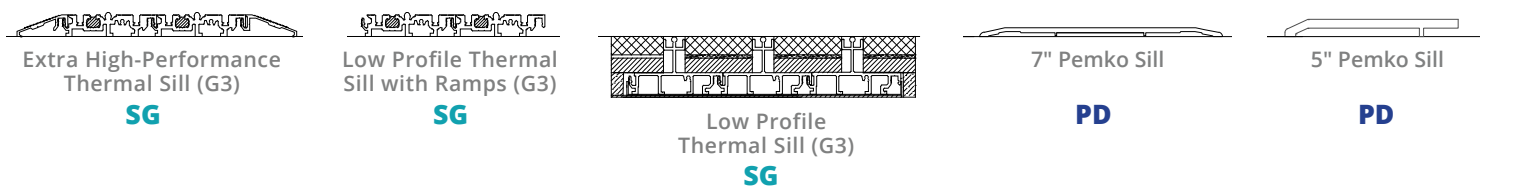
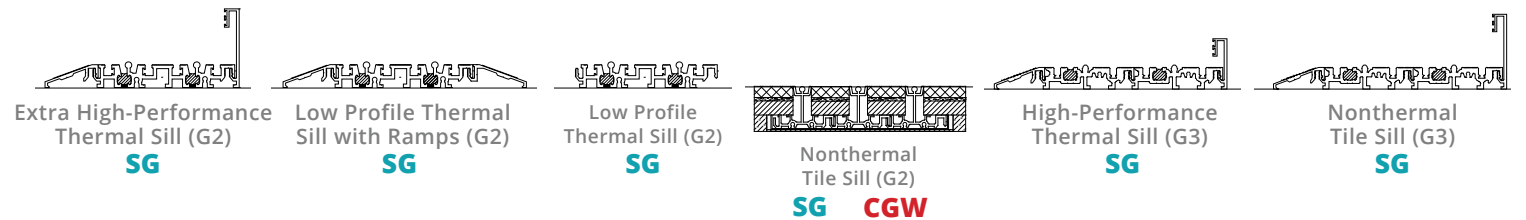
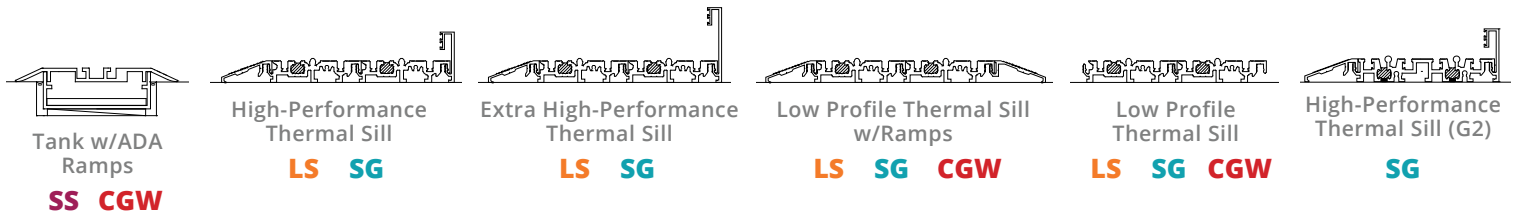
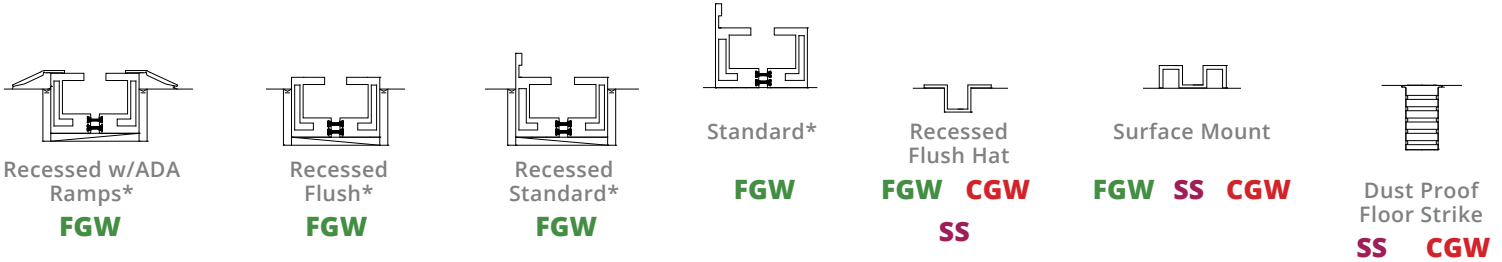

Glazing Options



LOW-E GLASS

Low-E glass has a transparent thin coating applied to the encapsulated glass surfaces that reflect heat back to its source, keeping the sun's heat out in the summer, and the structure's warmth in during the winter. We offer several variations of tint intensity.

- **LoE 272:** Our most common glazing, allows for clear views with the thermal benefits of Low-E glass.
72% VISIBLE LIGHT TRANSMITTANCE
0.41 SOLAR HEAT GAIN COEFFICIENT
- **LoE 366:** Increased performance with a slight tint, provides a comfortable space for both plants and people.
65% VISIBLE LIGHT TRANSMITTANCE
0.27 SOLAR HEAT GAIN COEFFICIENT
- **LoE 340:** Reduces solar heat gain drastically while allowing daylight to enter.
39% VISIBLE LIGHT TRANSMITTANCE
0.18 SOLAR HEAT GAIN COEFFICIENT

Other Low-E's from Guardian, PPG, and Viracon are available.

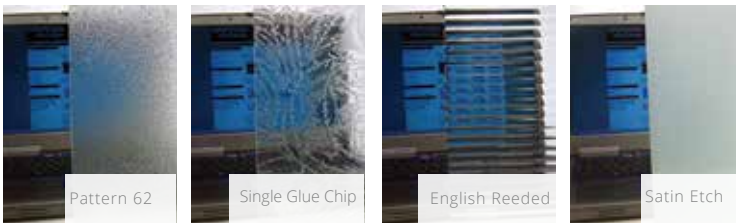

DECORATIVE GLAZING

Decorative glazing is a broad category consisting of art glass and other unique glazing options. Additional custom decorative options are also available.

- **Pattern 62:** Pattern 62 offers an attractive appearance, obscurity, and light transmission capabilities.
- **Single Glue Chip:** Single glue chip or glue chip is a texture that resembles frost on a window pane during the winter.
- **English Reeded:** English Reeded glass is a ribbed glass. The ribs of the glass run horizontally.
- **Satin/Acid Etch:** Satin etched adds the appearance of a 3-dimensional texture. It should be used on an unexposed surface in an IG unit.



POLYCARBONATE

Polycarbonate is a popular alternative to glass; it is lightweight, sustainable, incredibly strong, and easily transported.

- **Lumira® aerogel** can be used to fill the polycarbonate for increased thermal ratings, and greatly reduced sound transmission. Another benefit of incorporating Lumira® aerogel is glare reduction — the diffused daylight offered by polycarbonate creates bright, even lighting in any space. Sustainable purchasing, optimum energy efficiency, occupant comfort, low emissions, and daylighting are points where Lumira® aerogel can assist for LEED certification.



DYNAMIC GLASS

Dynamic glass can change automatically at specific temperatures, lighting conditions, or on demand. This allows for heat, light, and glare control any time of day.

- **Electrochromic** glass is highly energy efficient and switches between clear and tinted states on demand. In its tinted state, it blocks solar heat while controlling glare. In its clear state, it transmits more solar heat than typical Low-E glass.
- **Thermochromic** glazing darkens gradually and dynamically when heated by direct sunlight. The glass interlayer changes in reaction to ambient temperature and sunlight, managing a building's varied needs for passive solar heat gain, solar control, and natural daylight transmittance throughout the day.

Grid Options

Grids can be placed on the exterior and interior of the window. This type of grid can be applied to monolithic or insulated glass. For additional grid options and grid dimensions, visit solarinnovations.com.

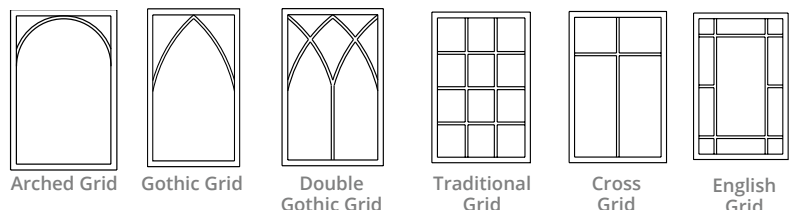

Screen Options

FOLDING SCREENS

Folding screens are hinged and fold accordion-style, mimicking the operation of folding glass walls. Swing-door screen panels can be integrated into the design.

SLIDING SCREENS

Sliding screens are generally used on large openings, most commonly on the exterior of sliding glass doors. The panels of this system can be pocketed into a wall cavity with either a center split or stack to the side when fully open.

SCREEN SWING DOORS

Screen swing doors are available for both terrace and French doors. The screen swing door is constructed with an aluminum frame that mimics the sightlines of our glazed swing doors. Handle selections can also be matched to the door.

FIXED SCREENS

Fixed screens are used on casement, awning, hopper, tilt turn, and sliding glass windows. Fixed screens are removable for cleaning.

B SERIES RETRACTABLE SCREENS

B Series screens are suited for large openings when a pleated screen option is preferred. These retractable screens can meet at a 90° corner to enclose a space with only one visible vertical division. This screen can be paired with folding glass walls, sliding glass doors, lift-slide doors, French doors and more.

C SERIES ECOSCREENS

C Series EcoScreens are available in an “all screen” configuration, an “all blind” configuration, or a combination of both. The blinds and screens are retracted from vertical cassettes on both sides of the opening and can be partially opened with an anti-slam feature. The blind portion of the unit can also function as a projector screen for your home theater system.

G SERIES - SHEER RETRACTABLE SCREENS

The G Series sheer retractable screen features a stylish, pleated material that can be operated with one hand. Units may include one to six panels and can be parted at any vertical rail. They have an ADA-compliant sill track and are available in several frame finish options. These screens can be designed to match the vertical rail alignment of the door system, minimizing sideline interruptions.

G SERIES - MILANO RETRACTABLE SCREENS

This Milano door screen can be integrated into either a single door or French door opening. The screens can be installed as a single unit or double panel, that is held in place with industrial-strength magnets when closed. Several frame finishes and sizes are available that will suit most openings.

S SERIES RETRACTABLE SCREENS

S Series screens are vertically retractable screens that feature a specialty zipper system which guides the fabric within the track and prevents insects from entering. This system can prevent sunlight from entering the room with the selection of black out fabric.



Folding Screens



S Series Retractable Screens



B Series Retractable Screen

Our Process



RESIDENCE
BABYLON, NY

Aluminum Curtain Wall with Tilt Turn Windows & G2 Folding Glass Walls



ODETTE WINERY
NAPA, CA

G3 Pivot Door

1 Contact Us

There are three convenient ways to work with Solar Innovations®. If you aren't quite sure where to start, call us directly at (800) 618-0669.

OUR DEALER NETWORK

Our extensive network of dealers throughout the United States have experience in the glazing industry and with our products. Dealers are frequently able to visit the job site and work one-on-one with the customer, aiding in design, local permits, and installation.

ARCHITECTS, GLAZIERS OR CONTRACTORS

Your architect, glazier, or contractor can work with our inside sales designer to ensure you receive the best product information and communication experience. Specifications, quotes, and drawings can be directed to you to review.

INSIDE SALES DESIGNER

Contact our inside sales designers directly to help plan and specify your project.

2 Planning & Quoting

There are various stages of planning due to the large variety of products, configurations, and options Solar Innovations® provides. Our in-house sales team can help you through the process while educating you on the differences between options. Whether you're a dealer, architect, business, or homeowner, we will help you achieve the best product results.

You can call us directly at (800) 618-0669 or complete an online quote form at solarinnovations.com. Our quotes have a quick turnaround time and we will work hard to give the most competitive pricing when quoting your project.

3 Place an Order

Our ordering process is streamlined and efficient, giving you all the requirements for your project, shop drawings, lead times, and shipment dates. Once your order is placed, you will be paired with a dedicated project manager to guide you through the process.

4 Installation

We can provide installation and service for all of our products within a six-hour radius of Pine Grove, PA. Our expertly trained team is registered to complete installation in over 16 states. When utilizing our installation services, an experienced team will be scheduled to install the project upon completion of shop fabrication. Our team is trained in the correct protocols to ensure safe, efficient, and accurate system installation.

RESIDENTIAL & COMMERCIAL

DOORS & WINDOWS | GLASS STRUCTURES | SKYLIGHTS

Folding Glass Walls
Slide & Stack Glass Walls
Clear Glass Walls
Sliding Glass Doors
Lift Slide Doors
Swing Doors
Pivot Doors

Casement Windows
Awning Windows
Tilt Turn Windows
Mulled Windows
Hopper Windows
Fixed Windows
Sliding Glass Windows

Folding Glass Windows
Curtain Walls
Wood Curtain Walls
Greenhouses
Conservatories
Sunrooms
Canopies

Pool Enclosures
Pool Houses
Walkways
Fixed Skylights
Curb Mount Skylights
Barrel Vault Skylights

Double Pitch Skylights
Dome Skylights
Single Slope Skylights
Pyramid Skylights
Walkable Skylights
Retractable Skylights
90° Operable Skylights



Most complete product line in the industry.



31 Roberts Road, Pine Grove, PA 17963

570 915 1500 | 800 618 0669

solarinnovations.com



SOLAR INNOVATIONS®
ARCHITECTURAL GLAZING SYSTEMS